

# Nuclear Physics and National Security in an Age of Terrorism

*Jerry Gilfoyle*

*Physics Department, University of Richmond, Virginia*

- Outline:
1. How do we assess the threat?
  1. Nuclear Weapons 101
  2. Catching terrorists before they strike.
  3. The Comprehensive Test Ban Treaty
  4. Assessing Risk.
  5. Summary and Conclusions.

# Assessing the Threat

## Assessing the Threat

- How does the weapon hurt us?



# Assessing the Threat

- How does the weapon hurt us?



- Can an opponent obtain and deliver it?



# Assessing the Threat

- How does the weapon hurt us?



- Can an opponent obtain and deliver it?



- How can we respond to the threat?

- prevention
- mitigation (*i.e.* cleanup, cures, *etc.*)
- retaliation



# Nuclear Weapons 101

## What Is Radiation?

- Emission or release of energy from atomic nuclei in the form of sub-atomic particles like photons, electrons, or other atomic nuclei.
- There is natural background radiation all around us that accounts for about 80% of the radiation on the Earth.
- Most man-made radiation is from X-ray machines and other medical procedures.
- Wide range of industrial uses.
  - sterilize packaged medical supplies at room temperature.
  - better curing of rubbers and plastics.
  - cure solventless paints and coatings with unmatched speed.
  - food processing.
  - waste stream treatment.

# Nuclear Weapons 101

- Fissile materials ( $^{235}\text{U}$ ,  $^{233}\text{U}$ ,  $^{239}\text{Pu}$ ) release enormous energies.
- Only about 8 kg of plutonium or 25 kg of highly-enriched uranium (HEU) is needed to produce a weapon.
- As each nucleus splits, it emits 2 or so neutrons plus lots of energy. Most neutrons leave without hitting other nuclei.
- Increasing the density creates a 'chain reaction' where the emitted neutrons cause other fissions in a self-propagating process.

A Chain Reaction

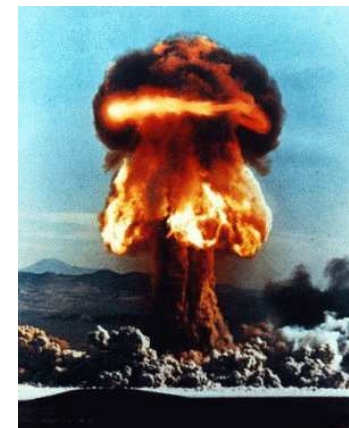
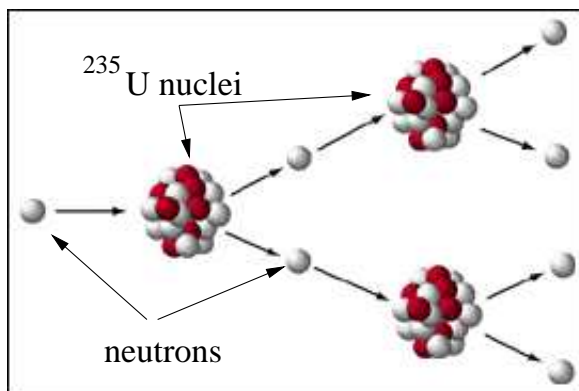

# Nuclear Weapons 101

- A uranium, gun-type nuclear weapon - High explosive pushes highly-enriched uranium at high speed down the gun tube and into the other piece of active material. The density increases enough to start the chain reaction.
- A two-stage, thermonuclear weapon. - High explosive crushes the plutonium primary to a density where fission can occur.
- The uranium and plutonium in the secondary burn and increase the temperature until fusion starts. The energy released by the fusion reaction raises the temperature even higher and burns more of the fission fuel.

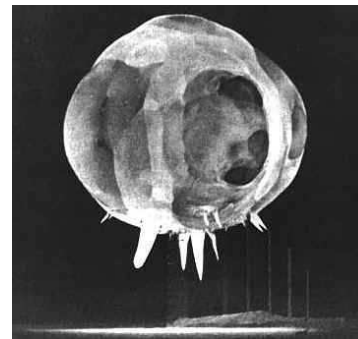
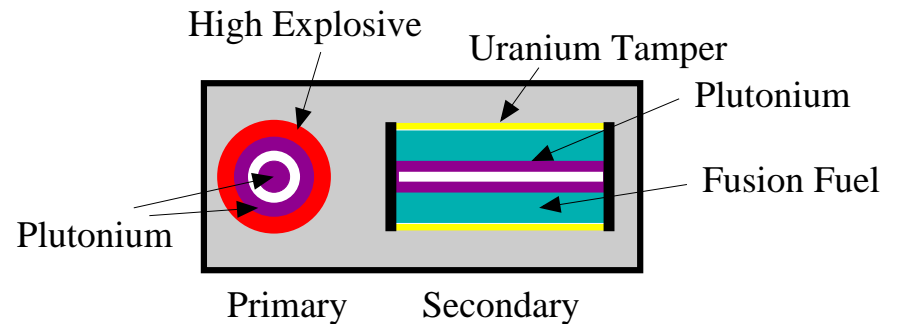
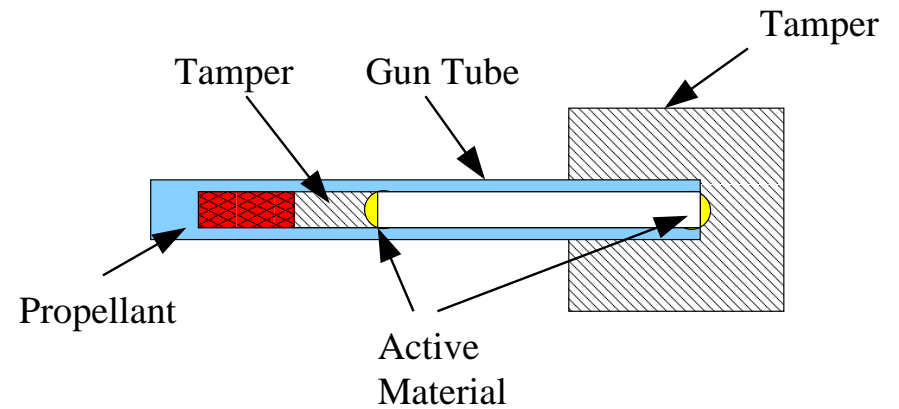

Nuclear fireball 1 *ms* after detonation (Tumbler Snapper). The fireball is about 20 m across.



## HEU Gun-Type Design

The figure to the right shows the 'Little Boy' design of the nuclear bomb dropped on Hiroshima. The fissile,  $^{235}\text{U}$  is shown in red. A cordite charge was detonated behind one of the pieces of  $^{235}\text{U}$  accelerating it to a speed of  $300\text{ m/s}$  before it struck the target to form a critical mass (see figure below). A neutron trigger/initiator was used to start the chain reaction.

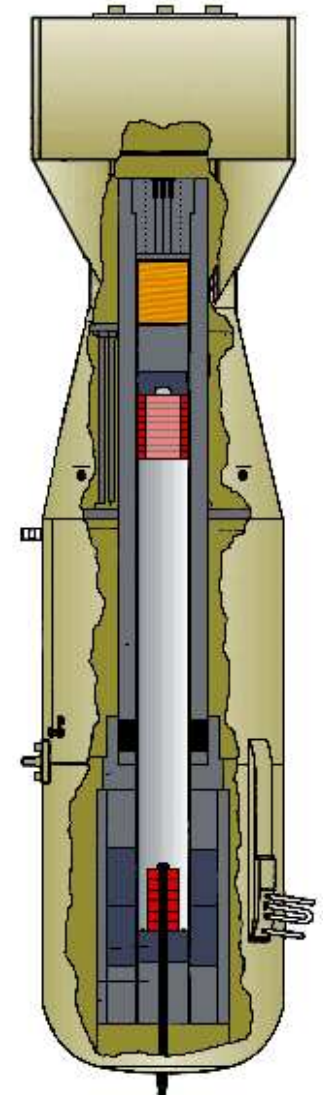
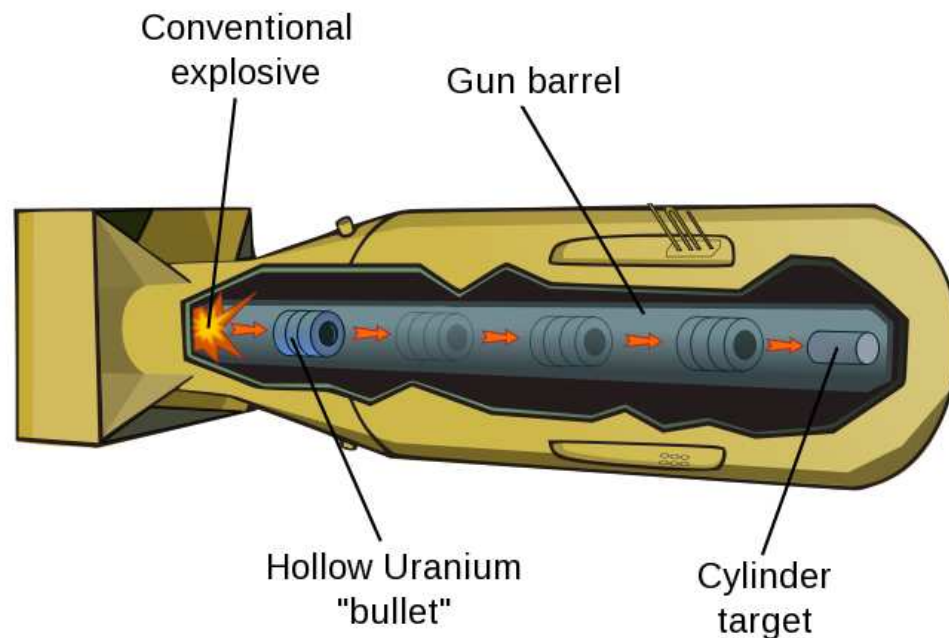

# Plutonium Implosion Design

The figure to the right shows the 'Fat Man' design of the nuclear bomb dropped on Nagasaki. The fissile,  $^{239}\text{Pu}$  is shown in red. Shaped, explosives were detonated around the spherical pieces of  $^{239}\text{Pu}$  compressing it to a high density. A neutron trigger/initiator was used to start the chain reaction.

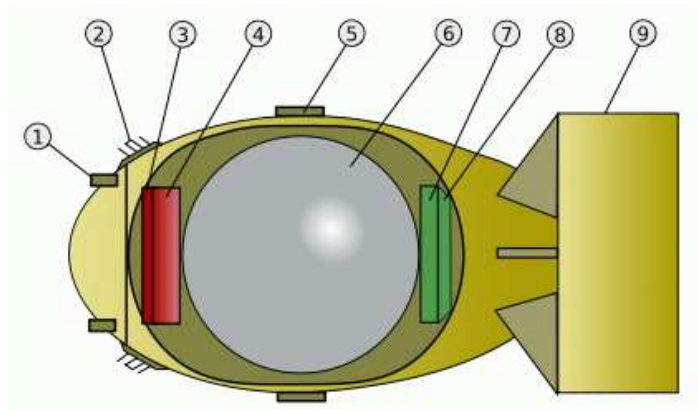

1. AN 219 contact fuse (four)
2. Archie radar antenna
3. Plate with batteries (to detonate charge surrounding nuclear components)
4. X-Unit, a firing set placed near the charge
5. Hinge fixing the two ellipsoidal parts of the bomb
6. Physics package (see details below)
7. Plate with instruments (radars, baroswitches and timers)
8. Barotube collector
9. California Parachute tail assembly (0.20-inch (5.1 mm) aluminium sheet)

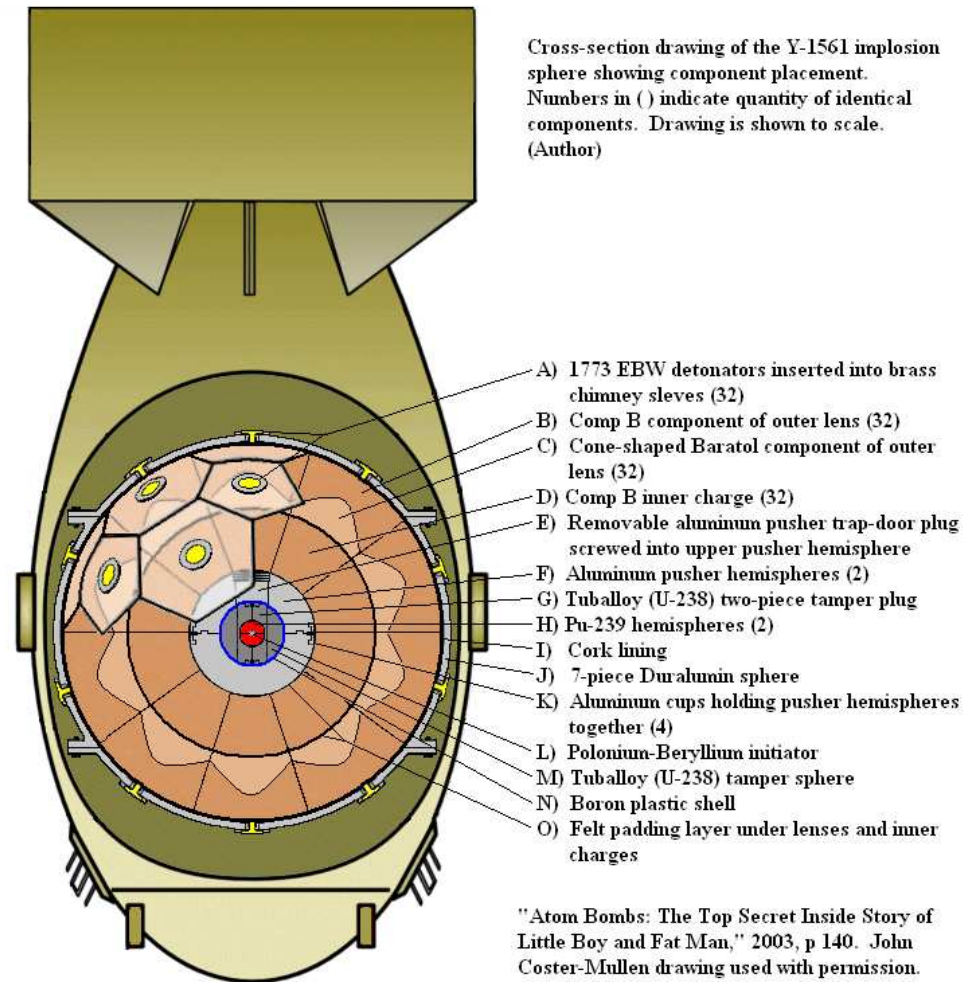

Cross-section drawing of the Y-1561 implosion sphere showing component placement. Numbers in ( ) indicate quantity of identical components. Drawing is shown to scale. (Author)

- A) 1773 EBW detonators inserted into brass chimney sleeves (32)
- B) Comp B component of outer lens (32)
- C) Cone-shaped Baratol component of outer lens (32)
- D) Comp B inner charge (32)
- E) Removable aluminum pusher trap-door plug screwed into upper pusher hemisphere
- F) Aluminum pusher hemispheres (2)
- G) Tuballoy (U-238) two-piece tamper plug
- H) Pu-239 hemispheres (2)
- I) Cork lining
- J) 7-piece Du aluminum sphere
- K) Aluminum cups holding pusher hemispheres together (4)
- L) Polonium-Beryllium initiator
- M) Tuballoy (U-238) tamper sphere
- N) Boron plastic shell
- O) Felt padding layer under lenses and inner charges

"Atom Bombs: The Top Secret Inside Story of Little Boy and Fat Man," 2003, p 140. John Coster-Mullen drawing used with permission.

# Weapons of Mass Destruction - Nuclear Bombs

- How does it hurt me?
  - Massive release of energy (blast, light) that can cause hundreds of thousands of deaths, long-term increase in cancer rates.

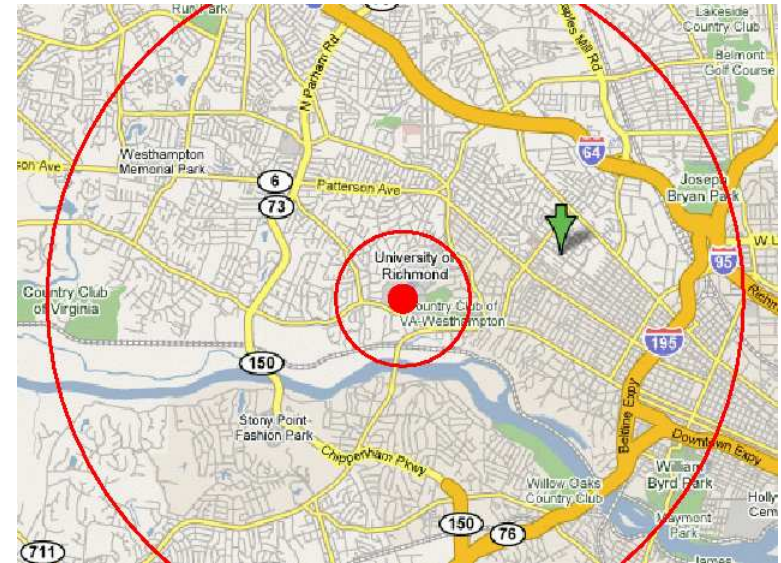

# Weapons of Mass Destruction - Nuclear Bombs

- How does it hurt me?
  - Massive release of energy (blast, light) that can cause hundreds of thousands of deaths, long-term increase in cancer rates.
- Can an opponent obtain and deliver it?
  - Building one from scratch can be done by nation-states, but not terrorists.
  - Building a bomb with stolen material is still difficult for terrorists.

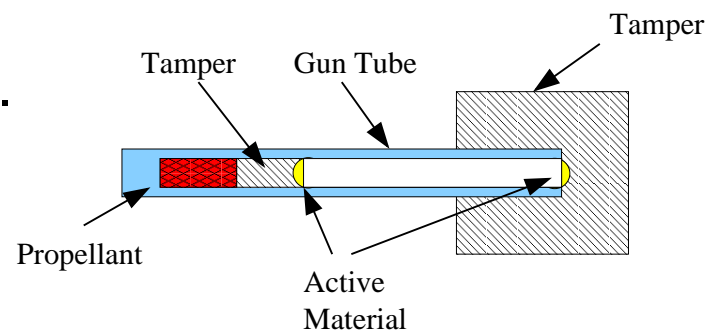
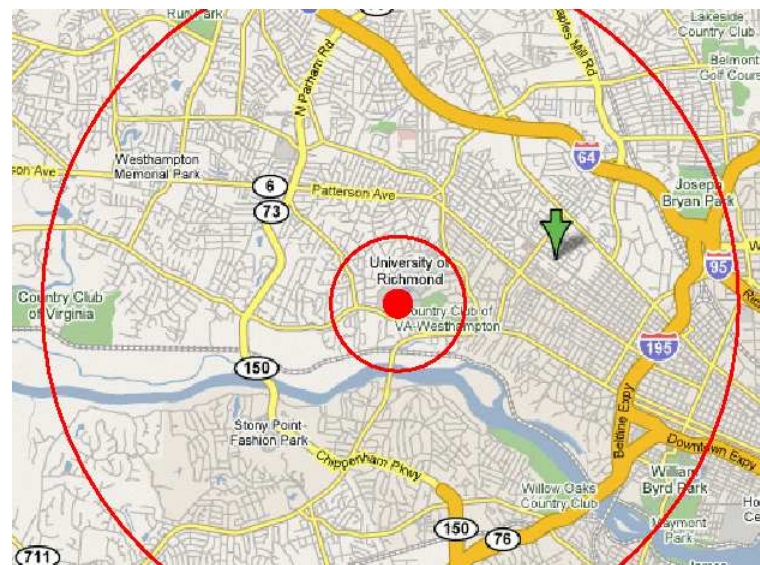



# Weapons of Mass Destruction - Nuclear Bombs

- How does it hurt me?
  - Massive release of energy (blast, light) that can cause hundreds of thousands of deaths, long-term increase in cancer rates.
- Can an opponent obtain and deliver it?
  - Building one from scratch can be done by nation-states, but not terrorists.
  - Building a bomb with stolen material is still difficult for terrorists.
- It's easy to smuggle things into the US. In 2000, about 700 tons of cocaine came into the US.

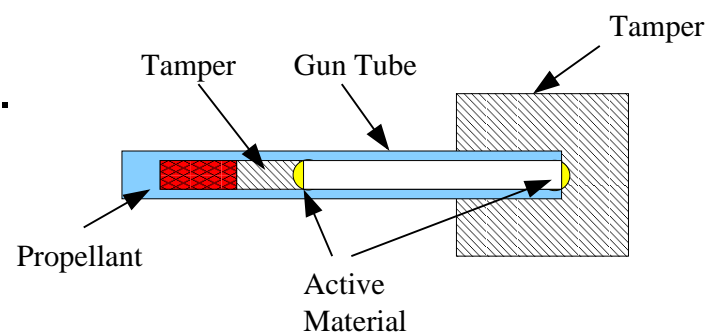
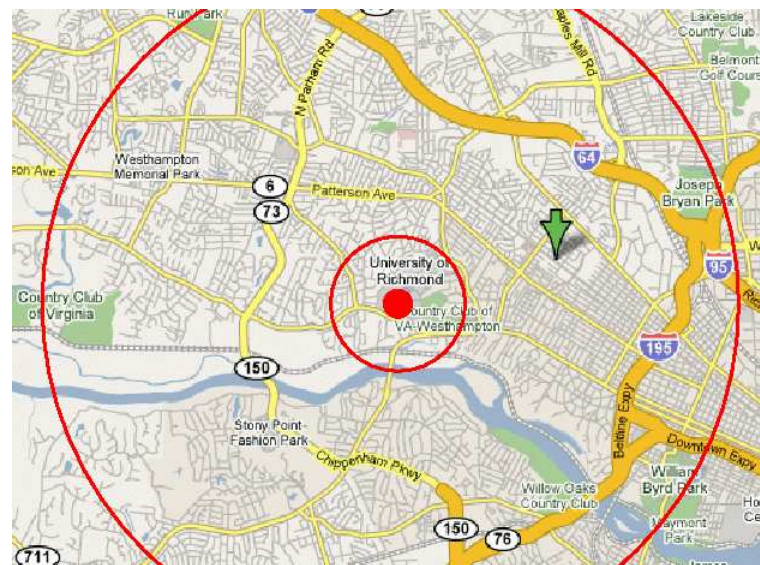

## Weapons of Mass Destruction - Nuclear Bombs

- How does it hurt me?
  - Massive release of energy (blast, light) that can cause hundreds of thousands of deaths, long-term increase in cancer rates.
- Can an opponent obtain and deliver it?
  - Building one from scratch can be done by nation-states, but not terrorists.
  - Building a bomb with stolen material is still difficult for terrorists.
- It's easy to smuggle things into the US. In 2000, about 700 tons of cocaine came into the US.
- Primary responses are prevention, threat of retaliation (deterrence).

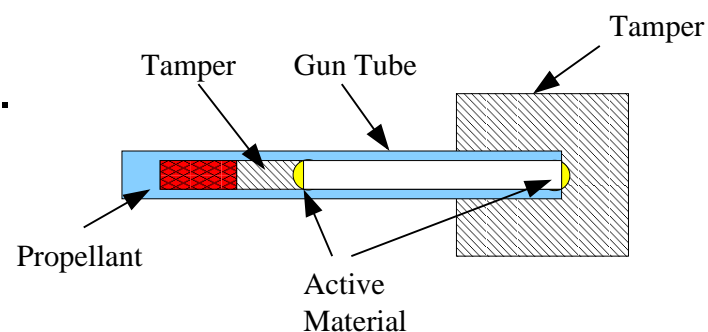
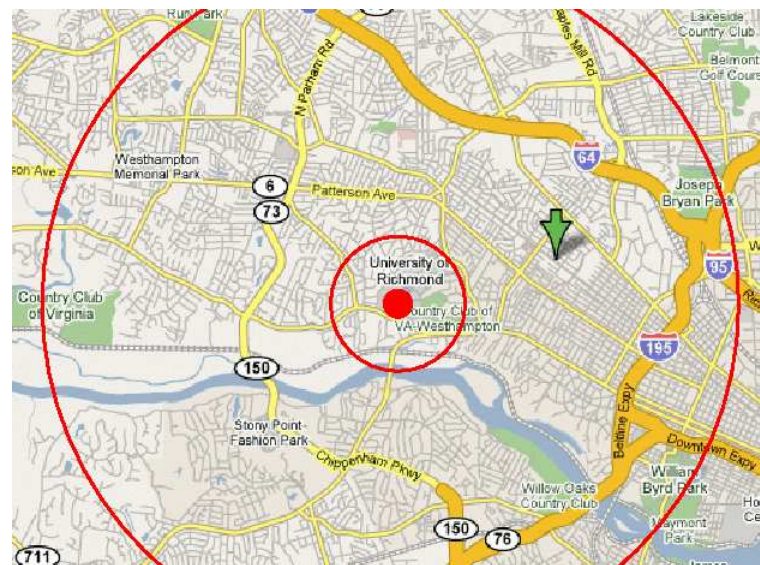

## WMD 101 - Radiological ('Dirty') Bombs

- Conventional explosive with radioactive material mixed in.
- How does it hurt me?
  - Initial damage from blast; far fewer casualties than a nuclear bomb.
  - Panic may be a major problem.
  - Increases in long-term cancer rates.
  - Clean-up could be costly.
- Can an opponent obtain and deliver it?
  - Many non-weapons-grade nuclear materials are vulnerable.
  - The technology is not much different from conventional explosives.
- Response is focused on prevention and cleanup.

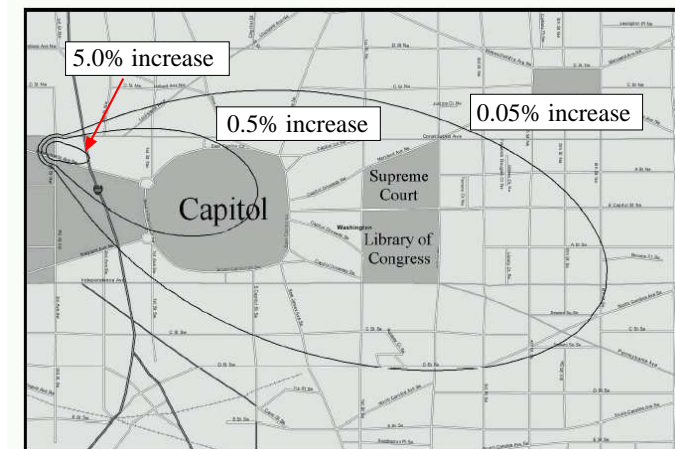

**Weapon of mass disruption!**

## Stopping a Terrorist Attack

- We have open borders both physically and electronically.
- More and more activities leave an electronic signature (*i.e.* RFIDs).
- Computing power is getting cheaper.
- Bandwidth is growing.
- Wireless is becoming pervasive.
- Volume of available data is huge.



Can we find the electronic signature of terrorists before they act?



# Ant Algorithms

- How do ant colonies find food?
  1. Send out lots of ants to search randomly. They follow trails left by other ants and leave trails of their own.
  2. Once they find food the ants follow their trail home marking the route twice.
  3. Successful ants will mark similar paths for other ants to follow so highways to the food source are created.
- What happens when the food runs out? Pheromones evaporate.
- What happens when a traffic jam occurs? Other routes are found.

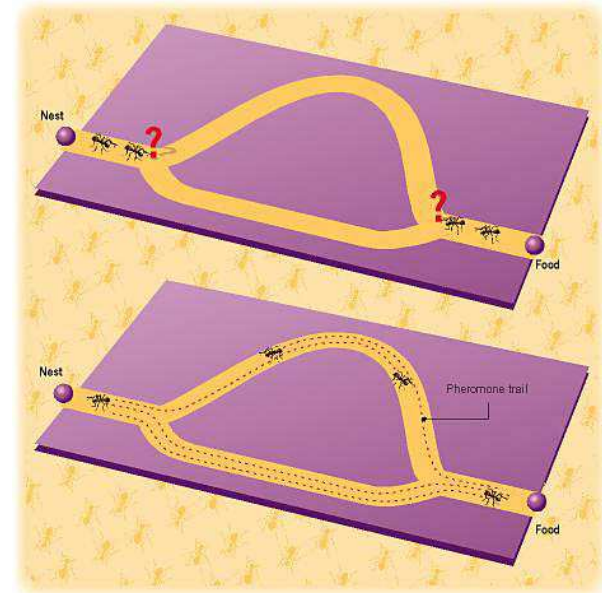

**A group of dumb 'agents' acts smart!**

## Does It Work In the Laboratory?

- Being studied in a wide variety of areas especially in communications networks.<sup>2</sup>
- Compared well with other algorithms in performing clustering and sorting of data.<sup>3</sup>
- Used in swarms of robots for prey retrieval, movement in rough terrain, and measuring complex areas.
- Other optimization problems: sequential ordering, quadratic assignment, vehicle routing, scheduling, graph coloring problem and partitioning.

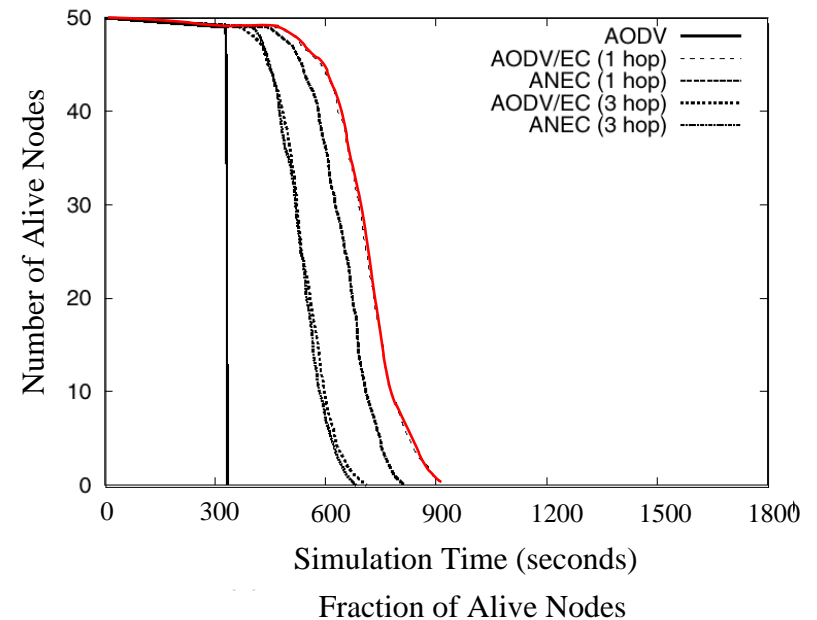

<sup>2</sup> C.Srisathapornphat and C.Shen, Comp. Comm. Net., Proc. ICCCN 2003, p 32-37 (2003).

<sup>3</sup> J.Handl, J.Knowles, and M.Dorigo, *On the Performance of ant-based clustering in Design and application of hybrid intelligent systems*, IOS Press Amsterdam (2003).

## Does It Work in the Field?

- Corporations now use data mining techniques to analyze their companies and 'characterize' their customers.
  - Models of each customer are developed based on their buying habits, inquiries, *etc.*
  - Models are used to target marketing, predict future buying behavior of customers (You!), identify gaps in services.
- The DARPA Information Awareness Office was started to fund projects to develop new computing methods for surveillance (*dataveillance*) and gather information “useful for preemption, national security warning, and national security decision making.”<sup>4</sup>
- Other federal agencies carry on a variety of surveillance and monitoring activities designed to identify terrorists.

<sup>4</sup> Information Awareness Office, <http://www.darpa.mil/iao/>, accessed 7/24/02.

**Are There Customers/Users/Victims?**

## Are There Customers/Users/Victims?

- Some say 'GO!'.
  - Businesses identify customers.
  - Target services.
  - Near real-time monitoring of business.
  - Improve the bottom line.
  - Industry ↔ Homeland Security.

“Good Privacy is Good Business.”

*Malcolm Crompton,  
Federal Privacy  
Commissioner*

## Are There Customers/Users/Victims?

- Some say 'GO!'.
  - Businesses identify customers.
  - Target services.
  - Near real-time monitoring of business.
  - Improve the bottom line.
  - Industry ↔ Homeland Security.
- Some say 'STOP!'.
  - Can privacy be maintained?
  - Public outcry over domestic surveillance.
  - DARPA Information Awareness Office loses funding in Congress.
  - Impact on civil liberties.

“Good Privacy is Good Business.”

*Malcolm Crompton,  
Federal Privacy  
Commissioner*

“Privacy is dead. Get over it”

*Scott McNealy,  
Sun Microsystems*

## Are There Customers/Users/Victims?

- Some say 'GO!'.
  - Businesses identify customers.
  - Target services.
  - Near real-time monitoring of business.
  - Improve the bottom line.
  - Industry ↔ Homeland Security.

“Good Privacy is Good Business.”

*Malcolm Crompton,  
Federal Privacy  
Commissioner*

- Some say 'STOP!'.
  - Can privacy be maintained?
  - Public outcry over domestic surveillance.
  - DARPA Information Awareness Office loses funding in Congress.
  - Impact on civil liberties.

“Privacy is dead. Get over it”

*Scott McNealy,  
Sun Microsystems*

**Who owns your information?** versus **Whose problem gets solved?**

# The Comprehensive Test Ban Treaty (CTBT)

- The CTBT bans all nuclear explosions for military or civilian purposes to limit the proliferation of nuclear weapons by cutting a vital link, testing, in their development.
- A network of seismological, hydroacoustic, infrasound, and radionuclide sensors will monitor compliance. Once the Treaty enters into force, on-site inspection will be provided to check compliance.
- The US has signed the CTBT, but not ratified it.

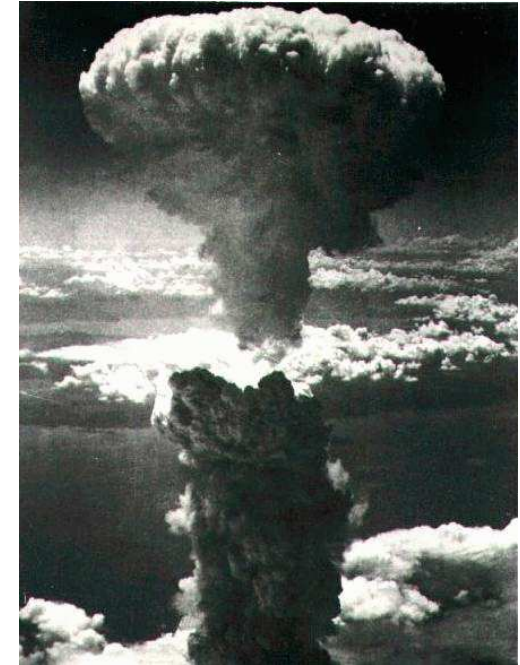

Green - ratified

Blue - signed

Red - outside treaty



# The CTBT Verification Regime

- The International Monitoring System (IMS), consists of 337 facilities that constantly monitor for signs of nuclear explosions. Around 70% of these facilities are already collecting data.
- Detection technologies:
  - Seismic: 50 primary and 120 auxiliary seismic stations monitor shockwaves.
  - Hydroacoustic: 11 hydrophone stations ‘listen’ for sound waves in the oceans.
  - Infrasound: 60 stations on the surface can detect ultra-low frequency sound waves (inaudible to the human ear) that are emitted by large explosions.
  - Radionuclide: 80 stations measure radioactive particles in the atmosphere, 40 also pick up noble gases.
- On-site-Inspection: If data from the IMS stations indicate that a nuclear test has taken place, a Member State can request for an on-site-inspection to be carried out.

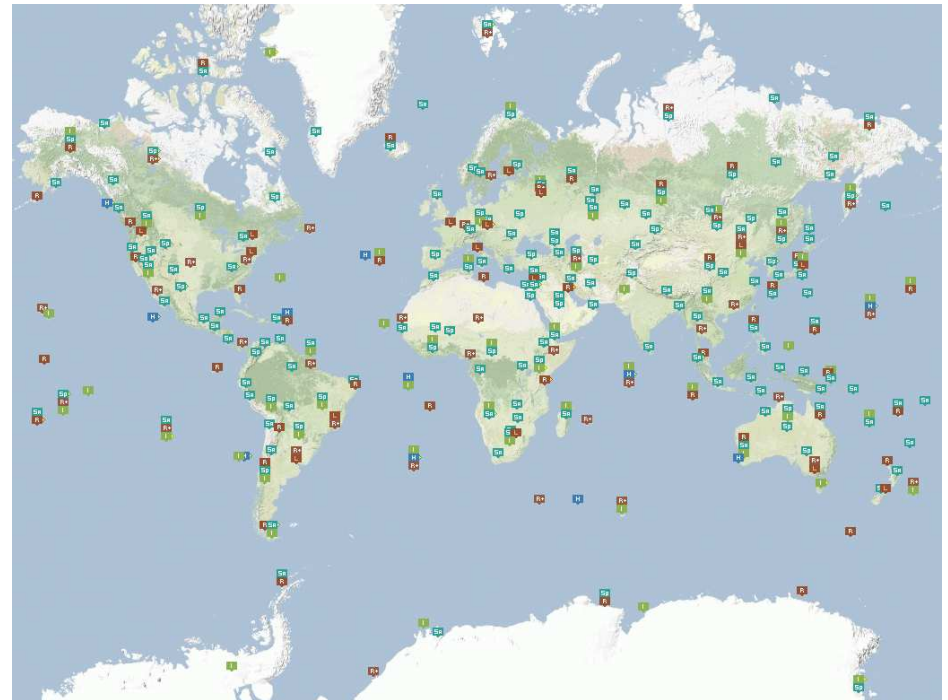
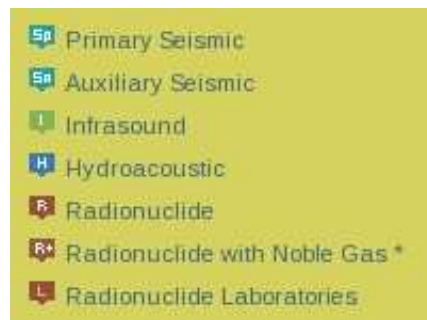

## Can an Opponent Cheat on the CTBT?

- U.S. and Russian experiments have demonstrated that seismic signals can be muffled, or decoupled, for a nuclear explosion detonated in a large underground cavity.
- Such technical scenarios are credible only for yields of at most a few kilotons.
- Seismic component of the International Monitoring System (IMS) for the CTBT is to consist of 170 seismic stations.
- The IMS is expected to detect all seismic events of about magnitude 4 or larger corresponds to an explosive yield of approximately 1 kiloton (the explosive yield of 1,000 tons of TNT).

What can be learned from low-yield, surreptitious blasts?

Can it extrapolated to full-up tests?

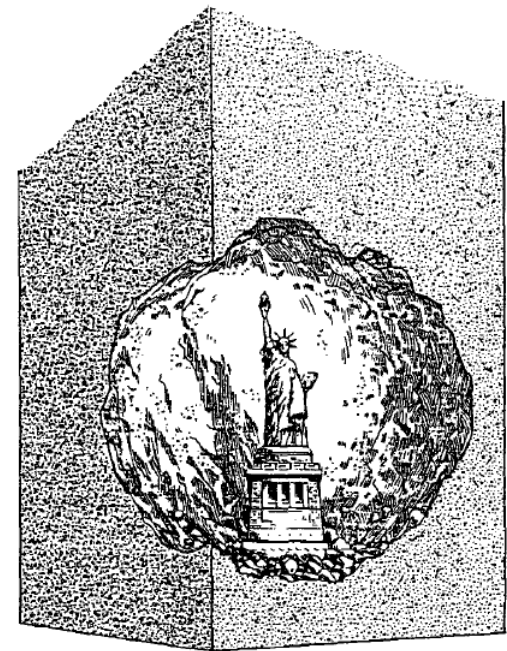

Demonstration of size of cavity needed to decouple a 5 kT blast.

## The 'Technical' Challenges to Security

- Controlling radioactive material especially in Russia.
  - Extensive US-Russian programs are already in place, but much work remains to be done.
  - International controls of non-weapons-grade nuclear material are weak in many countries.
- Nuclear Detection and Response.
  - Radioactive materials are difficult to 'see' in a sea of radioactivity.
  - Panic is a major concern after a 'dirty' bomb explosion.
  - Attribution capabilities are essential to the response and require international cooperation.
- Intelligence/Information
  - Increased processing power, network speed, and falling hardware costs will open new doors for surveillance.

## The Non-Technical Challenges to Security\*

- Build alliances and treaties.
  - Comprehensive Test Ban Treaty, Biological Weapons Convention, Chemical Weapons Convention, Kyoto, International Criminal Court.
- Strengthen US diplomacy.
  - Significant staffing shortfalls at many Foreign Service posts.
  - The US diplomatic corp is part of an extended defensive perimeter.
  - International affairs receives about 1% of the federal budget.
- Expand our commitment to democracy, the environment, energy, and economic development.
- Expand and globalize preventive threat reduction.

\* - 'Beating Terror', Senator Richard G. Lugar (R-Ind), *Washington Post*, Jan. 27, 2003; 'State Department: Staffing and Foreign Language Shortfalls Persist Despite Initiatives to Address Gaps', GAO-07-1154T August 1, 2007.

## Assessing Risk

What should you stay awake worrying about at night?

Deaths in 2005*	Cause
2,447,910	All causes
853,188	Heart Disease
45,043	Vehicle Accidents
62,804	Influenza/Pneumonia
31,769	Suicide

Deaths in 2005	Cause
17,694	Homicide
21,416	Poisoning
19,488	Falling
3,468	Drowning
3,144	Fire

\* National Vital Statistics Reports, **56**, no. 16, June 11, 2008.

## Summary and Conclusions

- When assessing threats keep the three rules in mind.
  1. How does the weapon hurt us?
  2. How does an opponent obtain and deliver it?
  3. How can we respond?
- There are some promising technological developments that give us hope.
- There are significant privacy issues.
- It's not clear if the economics is favorable.
- Terrorist threats must be examined within the context of other threats.
- Significant international cooperation is required to control fissile materials.

**Additional Slides**

## WMD 101 - Biological Weapons

- Release of a biological agent (anthrax, smallpox, salmonella).
- How does it hurt me?
  - The natural spread of the disease and the indiscriminate nature amplifies the impact of the disease.
  - Some weaponized forms could cause large number of casualties.
- Can an opponent obtain and deliver it?
  - Non-weaponized forms can/have been obtained via mail-order, dirt or stolen from labs.
  - Delivery is difficult for causing large numbers of casualties.
- Response is focused on prevention and mitigation.





## WMD 101 - Chemical Weapons

- Release of a chemical agent or toxin (botulinum, sarin, mustard gas).
- How does it hurt me?
  - Different agents have different effects (*i.e.*, incapacitation, blistering).
  - Some forms could cause large numbers of casualties, but most are limited. No amplification occurs.
- Can an opponent obtain and deliver it?
  - Many agents need only standard lab equipment.
  - Delivery is difficult for causing mass casualties.
- Response is prevention, mitigation, and cleanup.



Effect of chemical blistering agent <sup>1</sup>

<sup>1</sup> - *Chemical Warfare by Iraq in Iran-Iraq War*, Stockholm International Peace Research Institute, <http://www.iranvision.com/iraqchemicaluse.html>, Last accessed: 2/4/03.

## Detecting a Biological Attack

- The attack will not be obvious; it may take hours or days to know.
- Current biological diagnostics are very effective at identifying agents, but they're slow.
- We already have an infrastructure in place to start solving the problem; the US healthcare system.
- A successful attack could produce enough sick people to overwhelm the infrastructure so fast response time is essential.



**Can we detect the presence of biological agents quickly, inexpensively, and effectively?**

## A Micro-Cantilever for Biological Detection

- Fabricate a diving-board-shaped cantilever  $50 \times 200 \mu m$  using standard microchip manufacturing methods.
- Coat the top surfaces with antibodies for protein markers for specific diseases.
- The targeted proteins bind to the cantilever causing it to bend. The more proteins that bind the greater the bending.
- Detect the bending with a laser or other method.

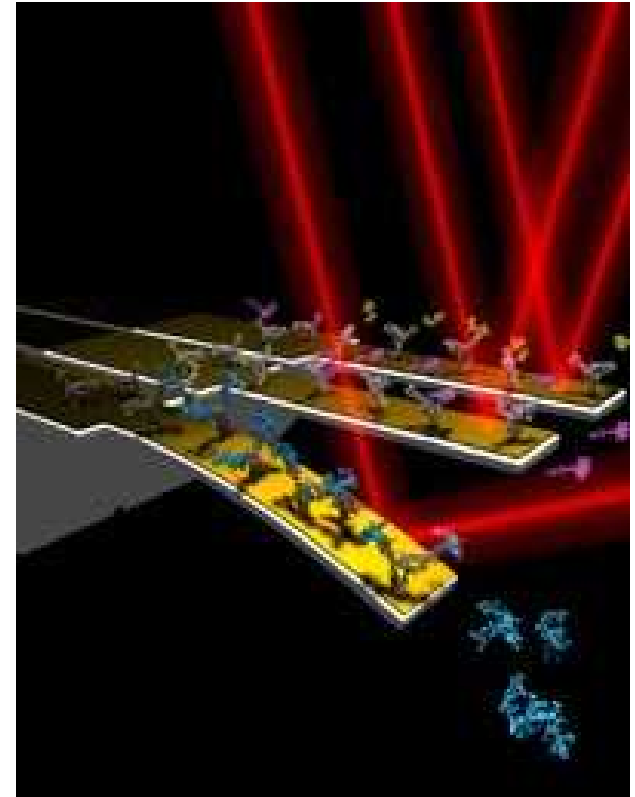

**A fast, inexpensive, sensitive biosensor!**

## Does It Work in the Laboratory?

- For PSA or prostate-specific antigen (a protein marker of prostate cancer which is the number two killer of men in the US) the technique is sensitive to 20 times below the clinically relevant threshold.
- Plastic explosives have been detected at the level of 10 ppt within 20 seconds of exposure.<sup>5</sup>
- Escheria Coli bacteria (a major cause of food-borne disease) has been detected at a limit of  $10^6$  cfu/mL with microcantilevers.<sup>6</sup>

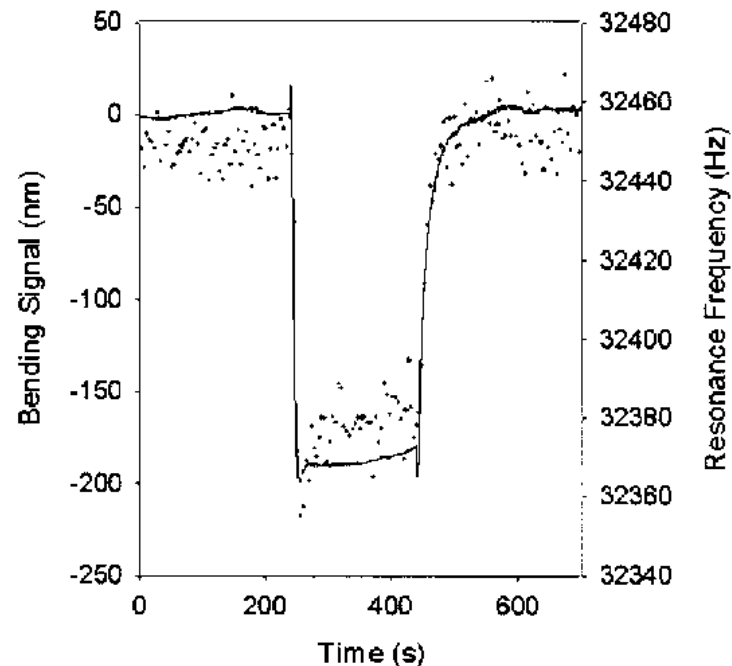

<sup>5</sup> L.A.Pinnaduwege, *et al.*, Appl. Phys. Lett., **83**, no. 7, (2003).

<sup>6</sup> J.Zhang and H.F.Ji, Analyt. Sci., **20**, 585 (2004).

## Does It Work in the Field?

- IR sensors have been developed that are cheaper than older alternatives by a factor of 25.
- The PSA technology has already been transferred to the private sector via a Cooperative Research and Development Agreement (CRADA) between Oak Ridge National Laboratory and several companies.
- The Microelektronik Centret (MIC) in Denmark is an academic research facility with 11 industrial collaborations including using microcantilevers for biodetection.
- Lots of activity in the research community for biodetection.
- Some companies are building or developing chemical or biosensors, but most of the companies are using microcantilevers for other purposes.

**Are There Customers/Users/Victims?**

## Are There Customers/Users/Victims?

- Some say 'GO!'.
  1. The \$700 billion/year healthcare industry.
  2. Homeland security agencies (federal to local) may use them.
  3. Synergistic relationship with manufacturing, *i.e.* improvements in chip manufacturing can improve the microcantilevers.
  4. Other challenges (*i.e.*, landmine detection) add incentives.

## Are There Customers/Users/Victims?

- Some say 'GO!'.
  1. The \$700 billion/year healthcare industry.
  2. Homeland security agencies (federal to local) may use them.
  3. Synergistic relationship with manufacturing, *i.e.* improvements in chip manufacturing can improve the microcantilevers.
  4. Other challenges (*i.e.*, landmine detection) add incentives.
- Some say 'MAYBE!'.
  1. It's expensive; about \$100 million to develop medical diagnostic tests.
  2. Drug companies may not want them.  
New genetic tests could identify patients that will not benefit from the company's drugs and reduce sales.

“most interesting marketing question of the next decade”

*Samuel Colella,  
Versant Ventures*



## A Non-Technical Solution: Preventive Threat Reduction

- The US spends taxpayer monies to remove and reduce weapons to increase homeland security.
- The Nunn-Lugar programs in cooperation with Russia spend  $\approx$ \$1B each year dismantling and securing the Russian nuclear weapons complex and destroying chemical and biological weapons.
- Operation Sapphire in 1995 removed 1300 pounds of insecure, weapons-grade uranium from Kazakhstan.
- Removal in summer 2003 of about 90 pounds of weapons-grade uranium from Vinca Institute in Serbia (with help from Ted Turner).
- Destruction of Scud missiles in Bulgaria.



Russian Missile Sub  
Dismantlement

## How Are We Doing?

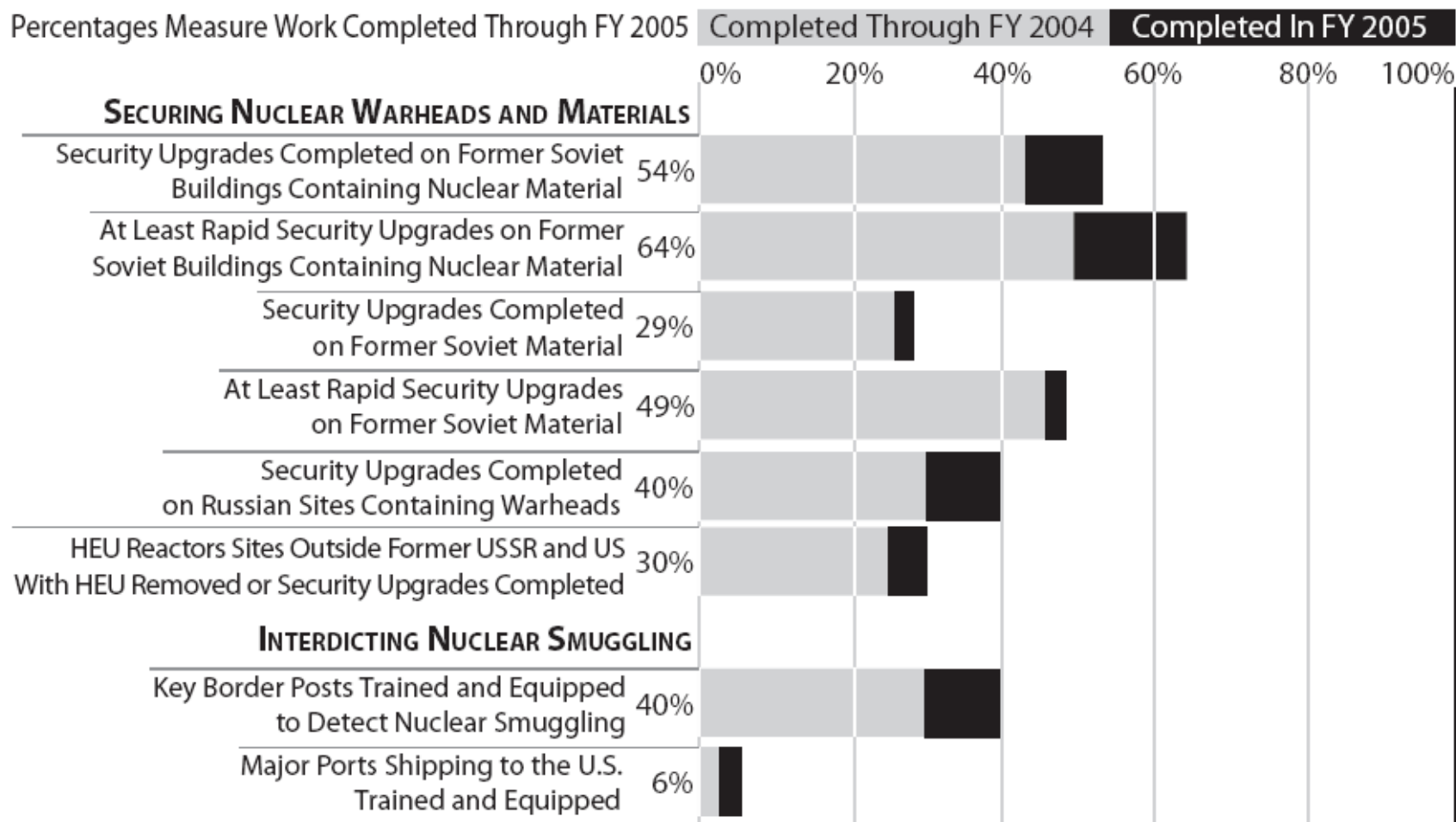

Reproduced from Matthew Bunn and Anthony Wier, *Securing the Bomb 2006* (Cambridge, Mass., and Washington, D.C.: Project on Managing the Atom, Harvard University, and Nuclear Threat Initiative, July 2006).

# How Are We Doing?

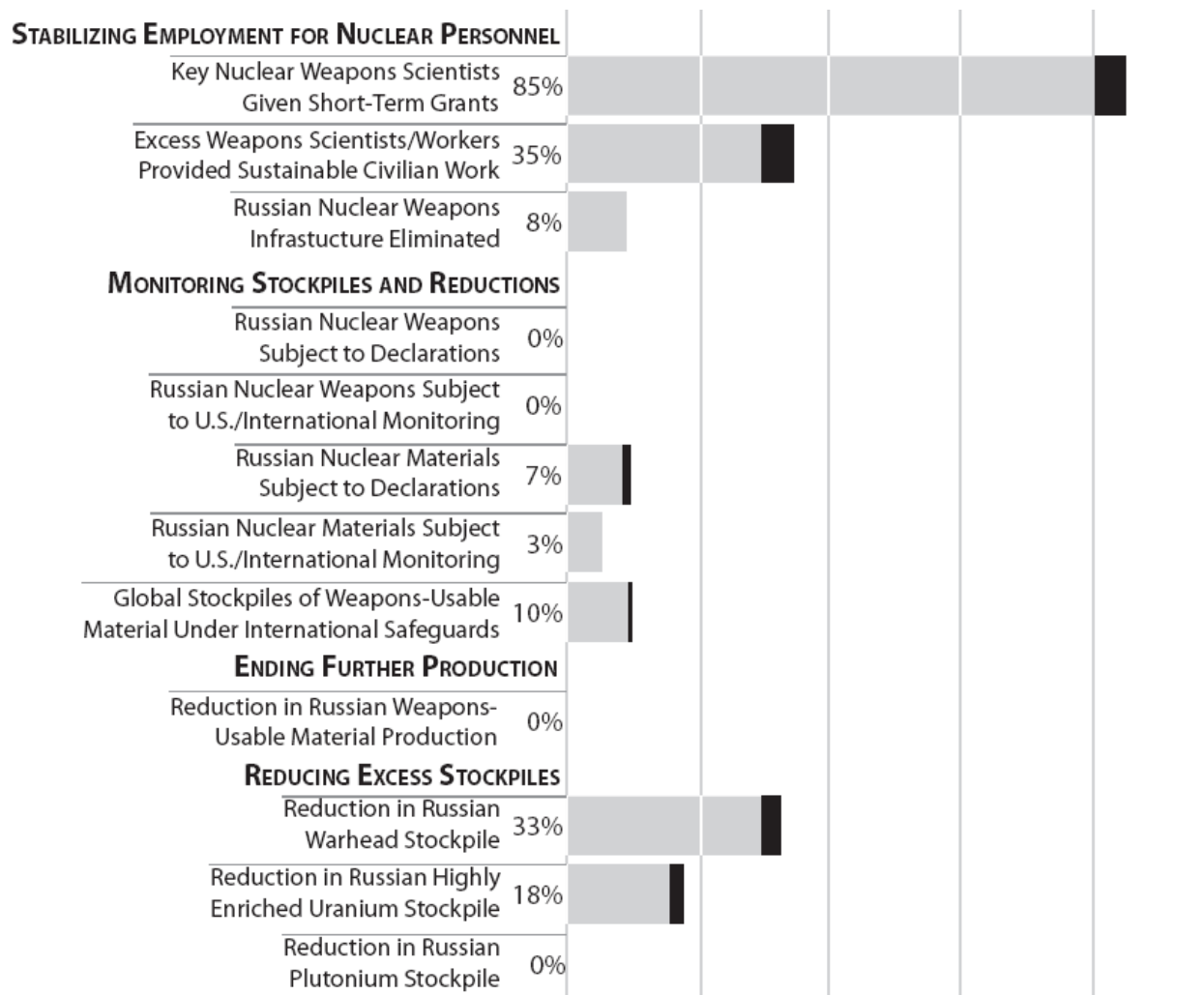

Reproduced from Matthew Bunn and Anthony Wier, *Securing the Bomb 2006* (Cambridge, Mass., and Washington, D.C.: Project on Managing the Atom, Harvard University, and Nuclear Threat Initiative, July 2006).