

Nuclear Power and the Spent Fuel Problem

1. The US has the largest number of reactors in the world (≈ 104).
2. The spent fuel is bad for you.
 - For a typical, 10-year-old, spent-fuel rod the radiation dose at one meter is 20,000 rem/hr.
 - Five thousand rem is fatal in about a week; typical annual dose in the US is about 1/3 rem.
3. The US now has about 45,000 tons of spent fuels stored around the country mostly in pools near the reactor.
4. The US project to build a long-term storage facility at Yucca Mountain has been halted.

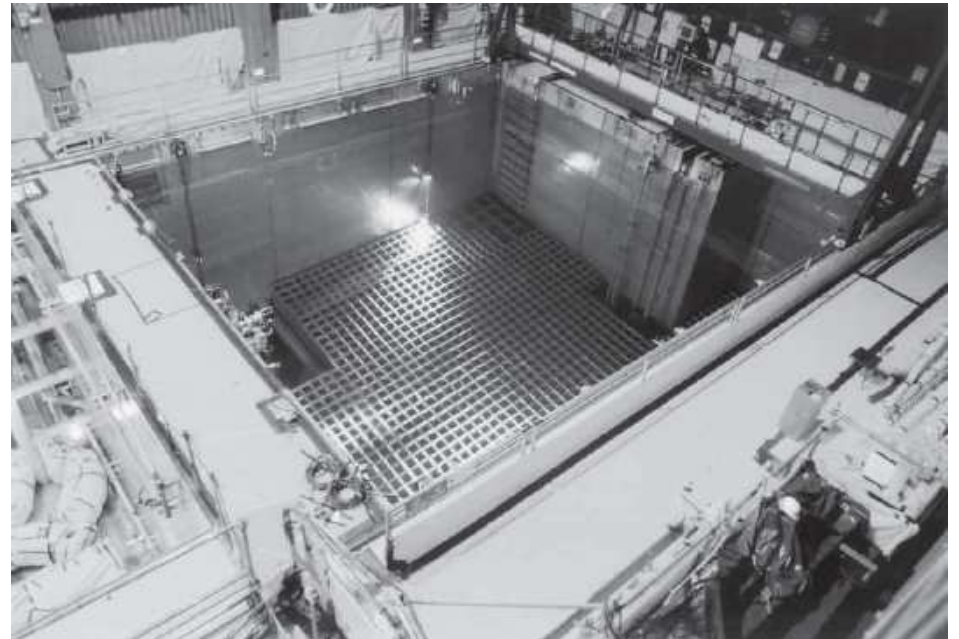

Shoot it into the Sun!

theguardian

News | US | World | Sports | Comment | Culture | Business | Environ
Data

News > UK news

Shoot it at the sun. Send it to Earth's core. What to do with nuclear waste?

Government advisers consider 14 ways of getting rid of the troublesome legacy

Paul Brown, environment correspondent
The Guardian, Wednesday 14 April 2004 06.55 EDT
[Article history](#)

NowPublic
Crowd Powered Media





Search: Stories

Home Help Newsroom Forum Member Rankin
Local World Culture Environment Tech & Biz He
Featured Tags: Afghanistan Crime India

World

OPINION The big lie with nuclear world waste, shoot it in the sun or elevate it into space

by SOLARLIFE | October 3, 2008 at 05:41 pm

Share:     

POPSCI THE FUTURE NOW

Login/Register | Newsletter | Subscribe |

GADGETS **CARS**

GALLERIES // VIDEOS // COLUMNS

Like <239 +7 0 Tweet <0 DIGG 64 1 point

FYI: Why Not Just Dispose of Nuclear Waste in the Sun?

By Bjorn Carey Posted 04.13.2010 at 1:14 pm 45 Comments



ACTON INSTITUTE Home About

POWERBLOG

"Power tends to corrupt, and absolute power corrupts absolutely."

Why Not Just Dispose of Nuclear Waste in the Sun?

posted by JORDAN J. BALLOR on TUESDAY, APRIL 13, 2010

6 Comments

PopSci follows up with the question I asked awhile back, "Why Not Just Dispose of Nuclear Waste in the Sun?"

The piece raises doubts about launch reliability: "It's a bummer when a satellite ends up underwater, but it's an entirely different story if that rocket is packing a few hundred pounds of uranium. And if the uranium caught fire, it could stay airborne and circulate for months, dusting the globe with radioactive ash. Still seem like a good idea?"

This is precisely why I raise the possibility of a modified space cannon to shoot the material that cannot be recycled into the sun.

Railguns!

- A railgun is an electrically-powered artillery gun that accelerates a conductive projectile along magnetic metal rails.
- Does not require propellant.
- Can reach high launch speeds.
- The US Navy launched a 7-lb projectile at 5,400 mph in the late 2000's (see it [here](#)).
- Could be used as a low-cost launch system *Launch to Space With an Electromagnetic Railgun*, Ian R. McNab, IEEE Transactions on Magnetics, 39, no. 1 (2003).

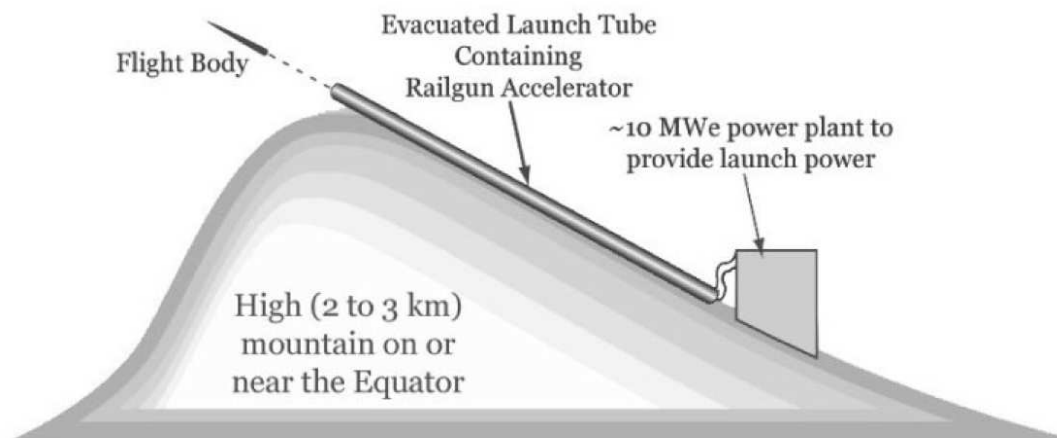
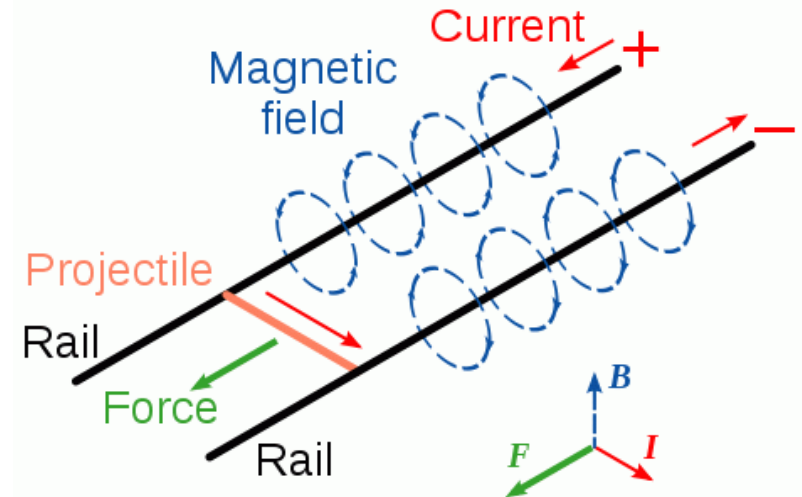

Shoot the Sun!

What is the trajectory of a projectile launched from the Earth's surface at a speed v_0 and direction ϕ as shown in the figure below? Get your answer in terms of v_0 , ϕ , the angular velocity ω , the masses, the distances L_E and L_S , and any other constants.

- Assume the projectile is launched from a point on the surface and radially outward at the angle ϕ as shown below.
- Consider only the gravitational forces from the Sun and the Earth.
- Assume the Earth and the Sun follow circular orbits around the center of mass of the Earth-Sun system. The Earth-Sun distance is $R_E = L_S + L_E$.

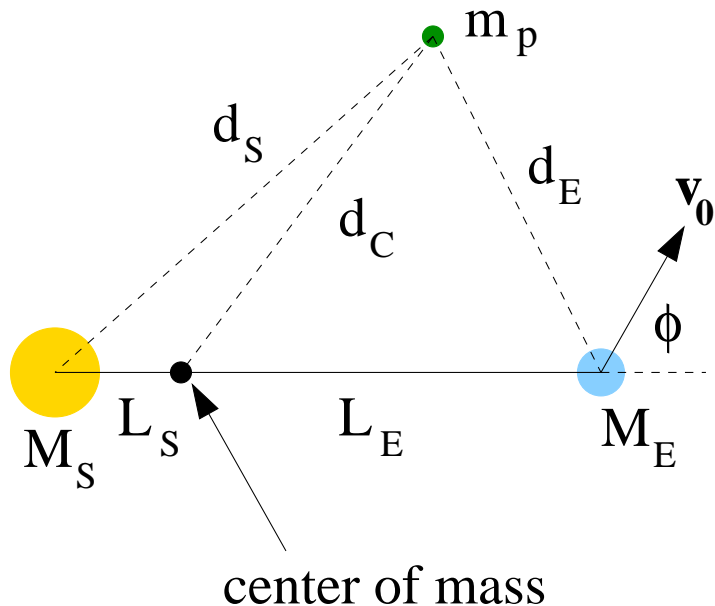

$$\begin{aligned}M_S &= 1.99 \times 10^{30} \text{ kg} \\M_E &= 5.97 \times 10^{24} \text{ kg} \\R_E &= 1.5 \times 10^{11} \text{ m} \\r_E &= 6.37 \times 10^6 \text{ m} \\r_S &= 6.96 \times 10^8 \text{ m}\end{aligned}$$

Newton's Law of Gravitation

$$\vec{F}_{12} = G \frac{m_1 m_2}{r^2} \hat{r}_{12}$$

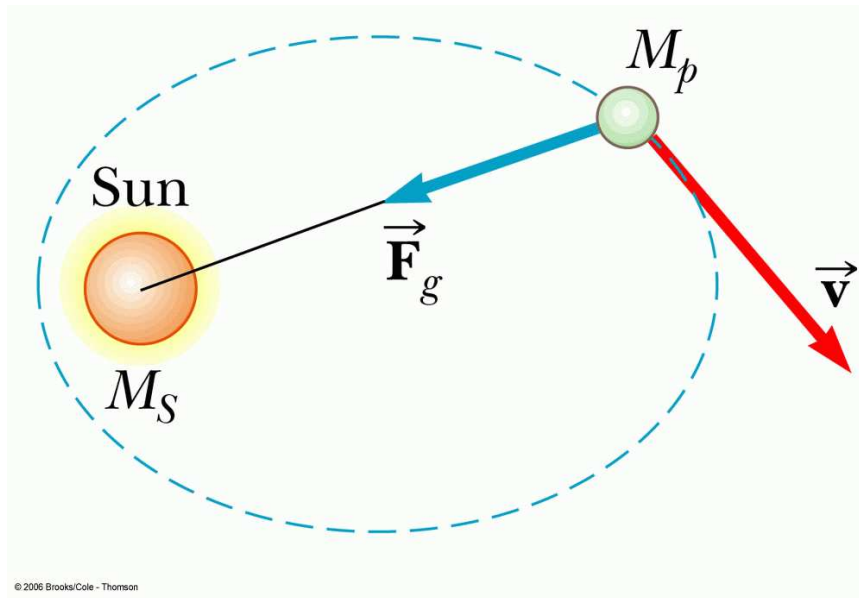
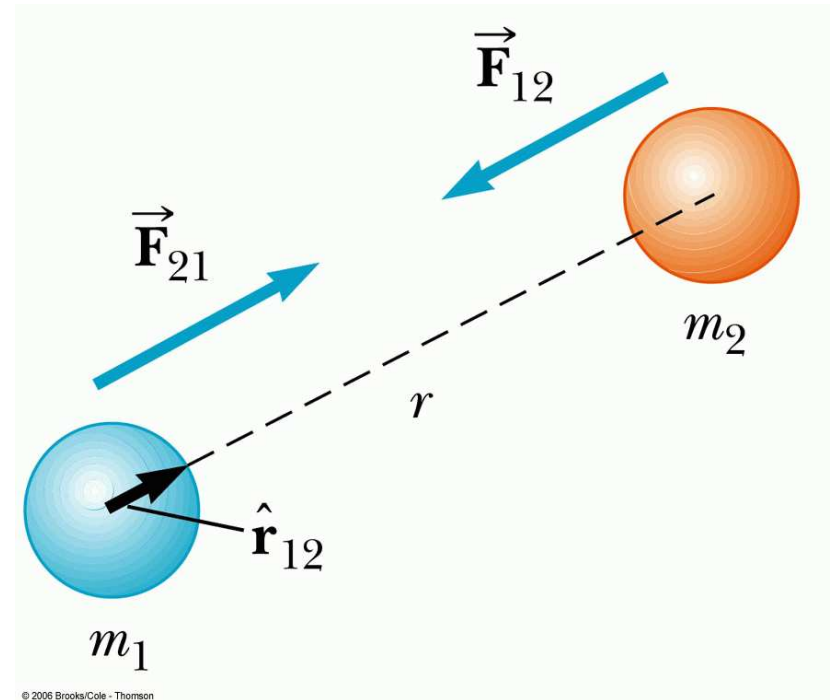

Newton's Law of Gravitation

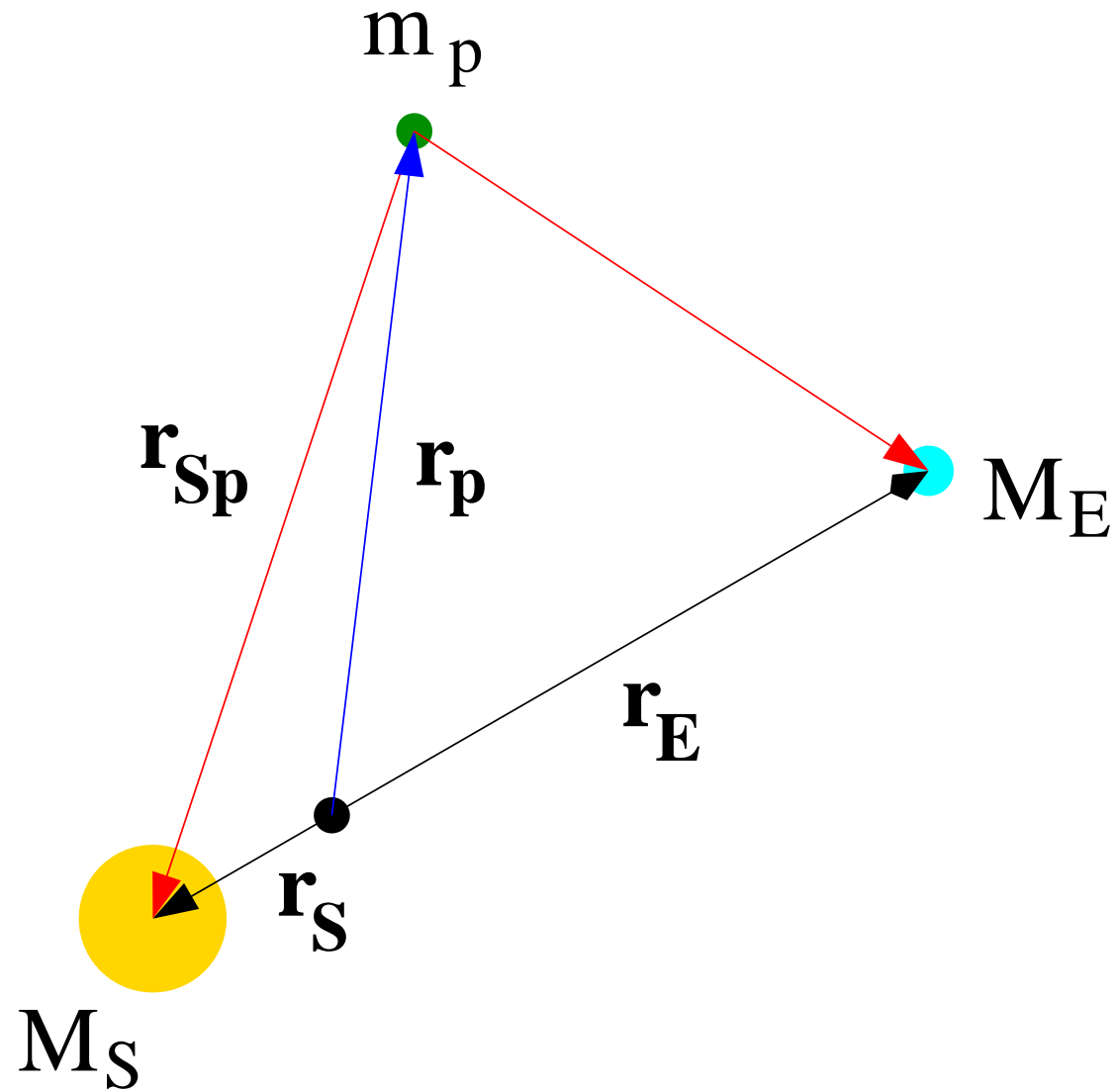

Launching the Projectile

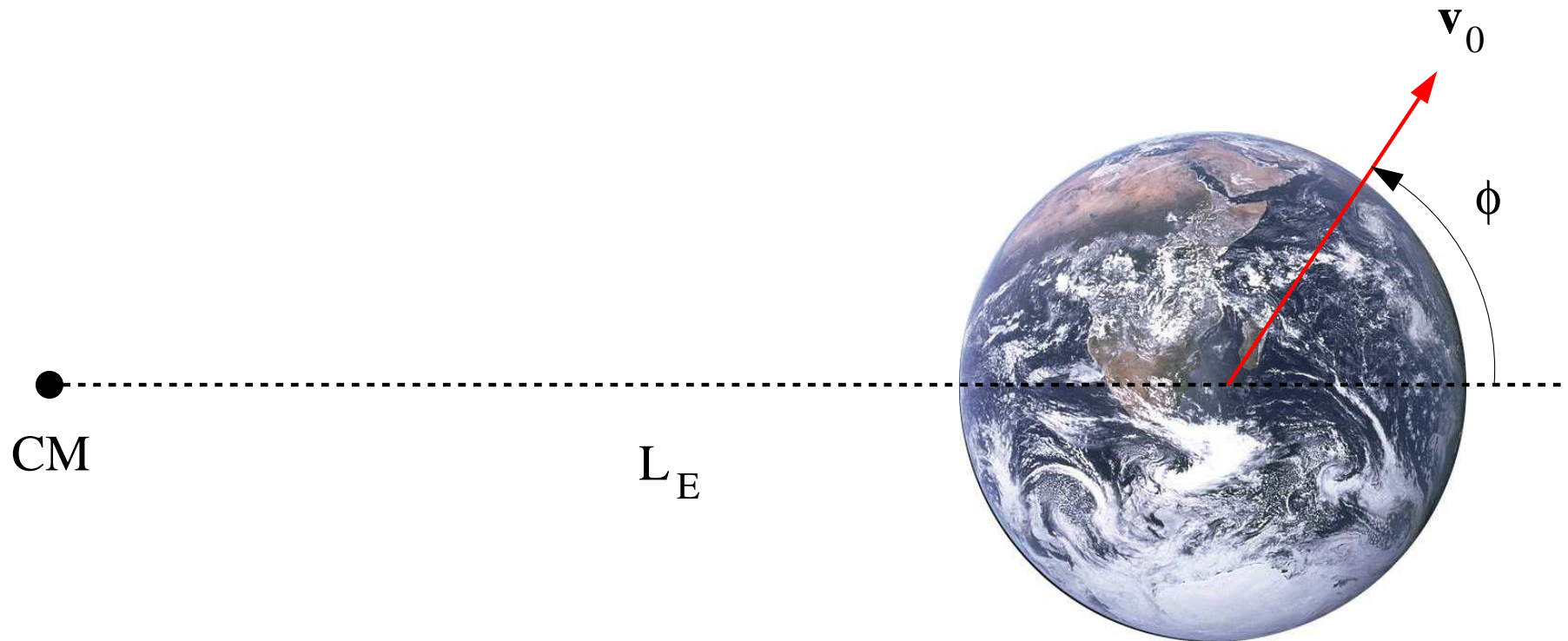

Launching the Projectile

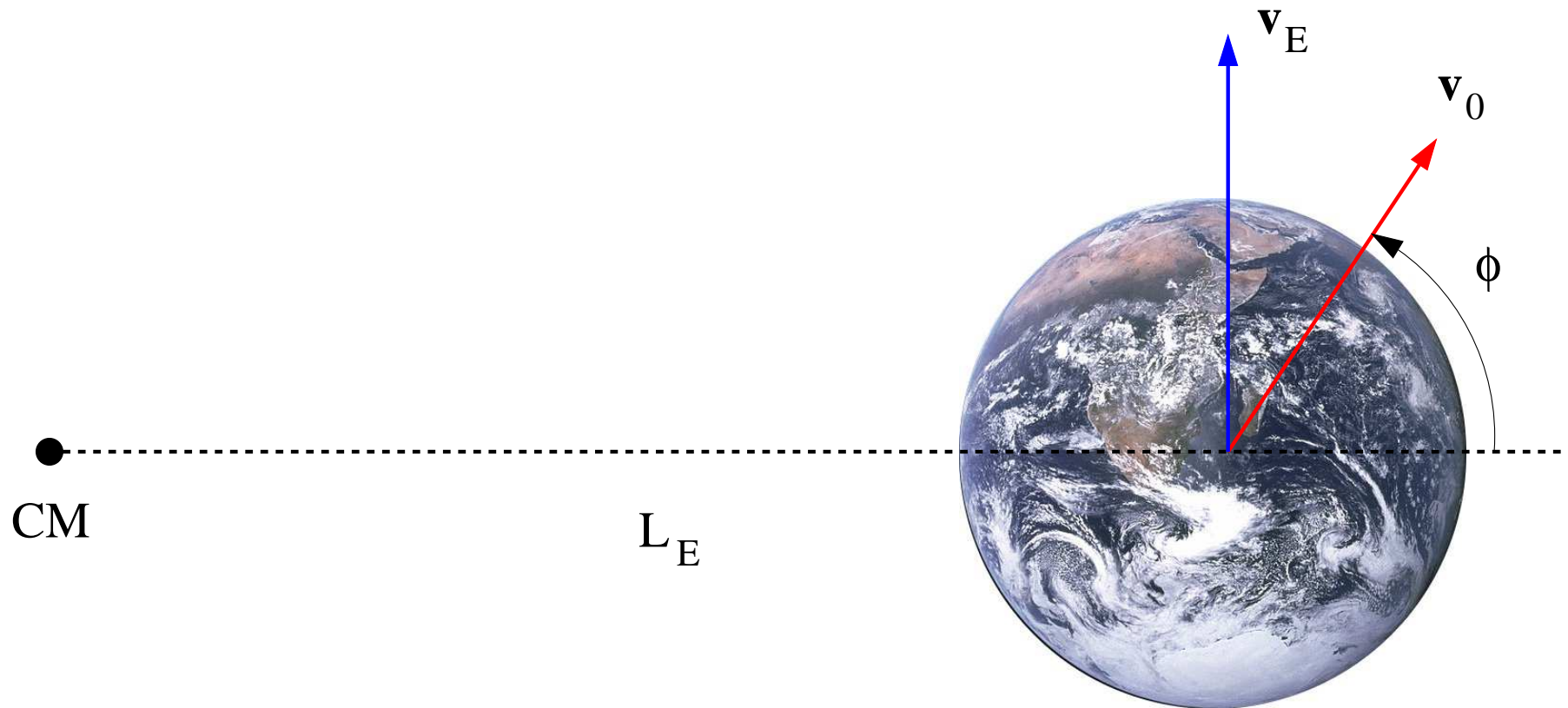

Initial Velocity

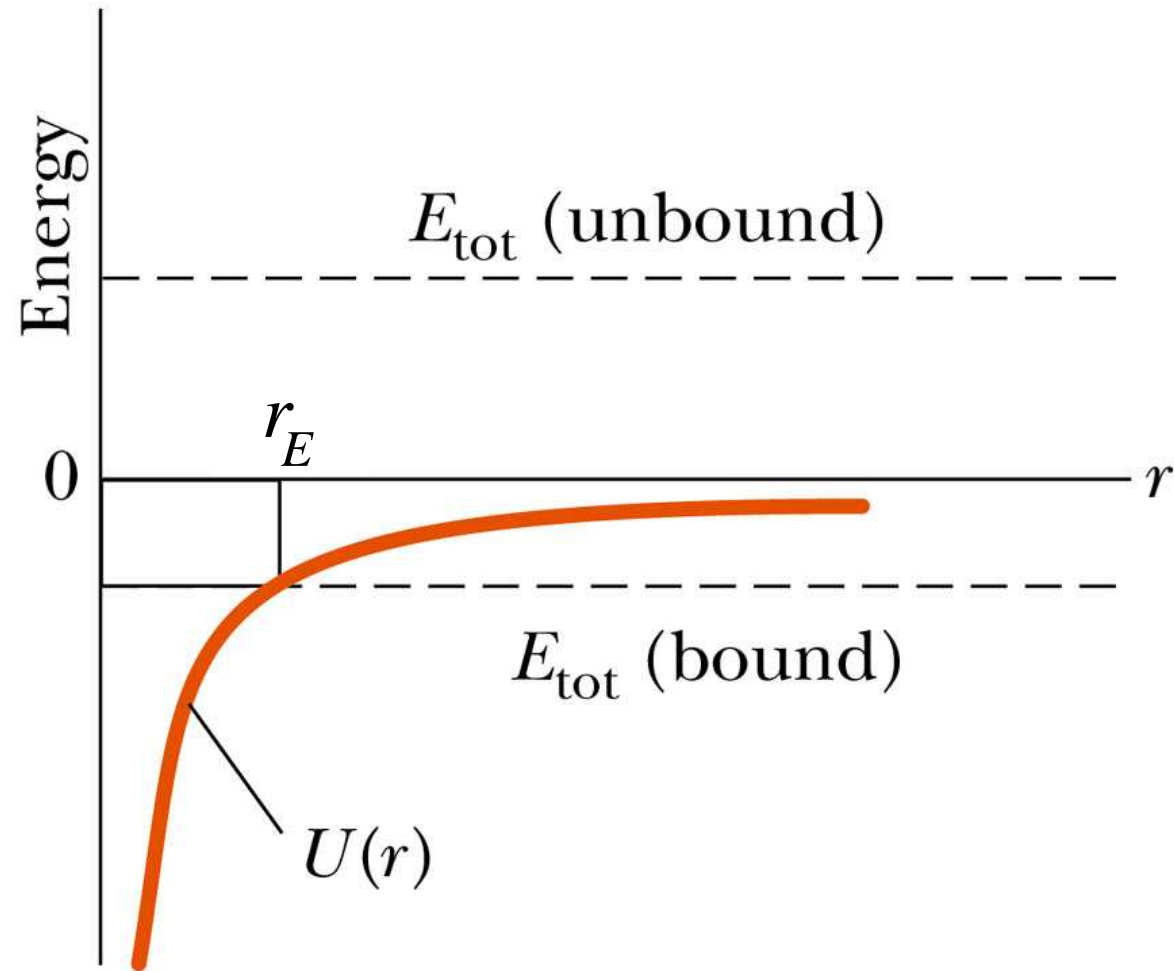

© 2006 Brooks/Cole - Thomson

Testing the Trajectory

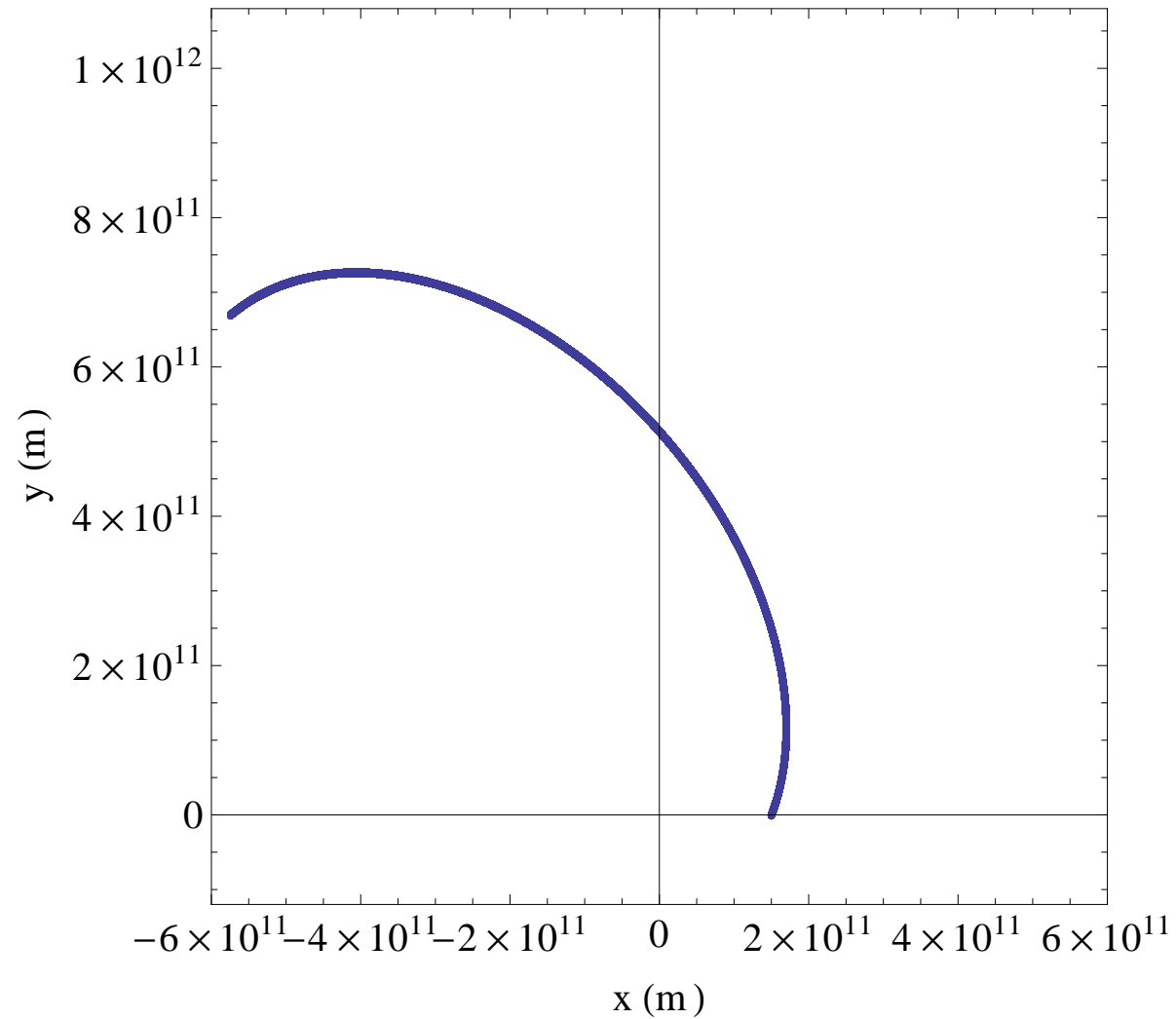

Phase-Space Plot

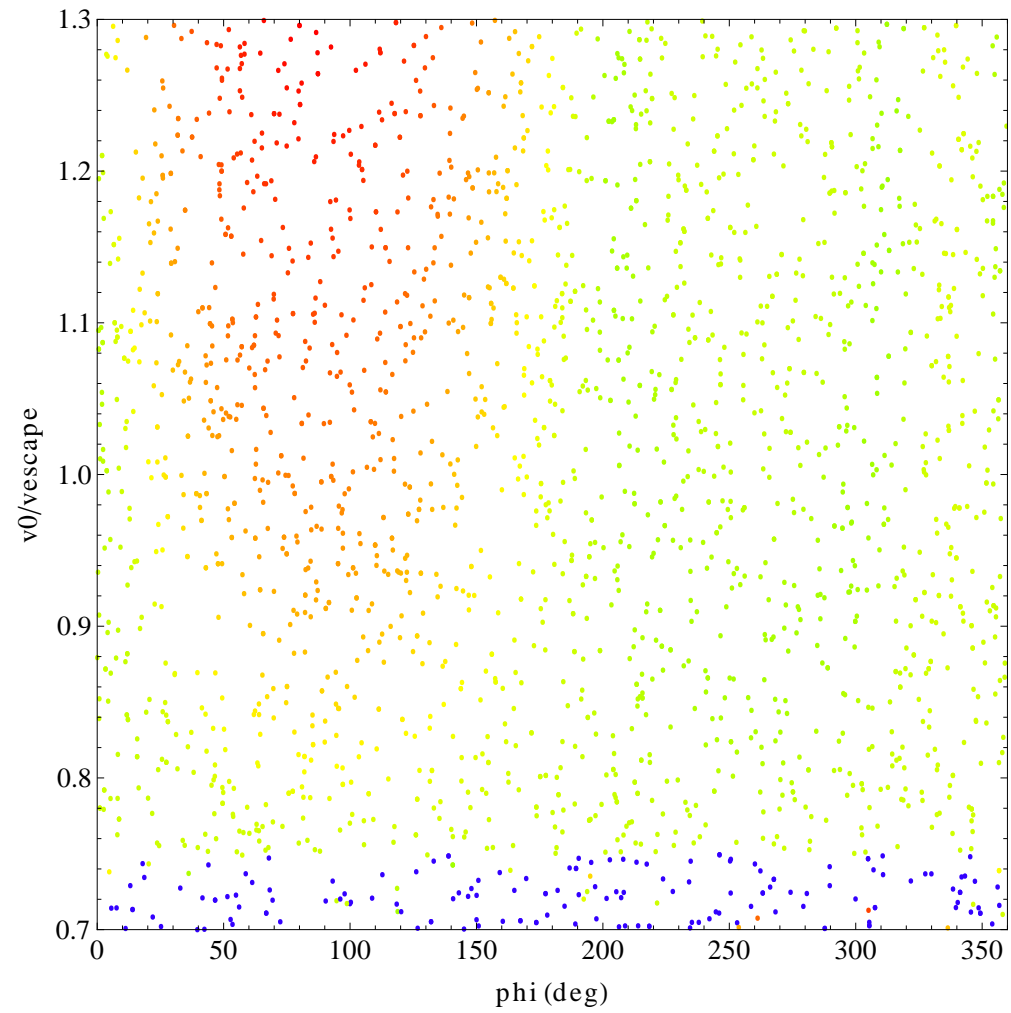

Richmond Computational Physics - The Cluster

- Research quality cluster exclusively for student use.
- Head node is a 64-bit machine with eight cores, 3.5 TByte of space and 12 GByte of memory.
- There are seven remote nodes each with eight cores.
- Running Red Hat Enterprise linux.
- You are here.

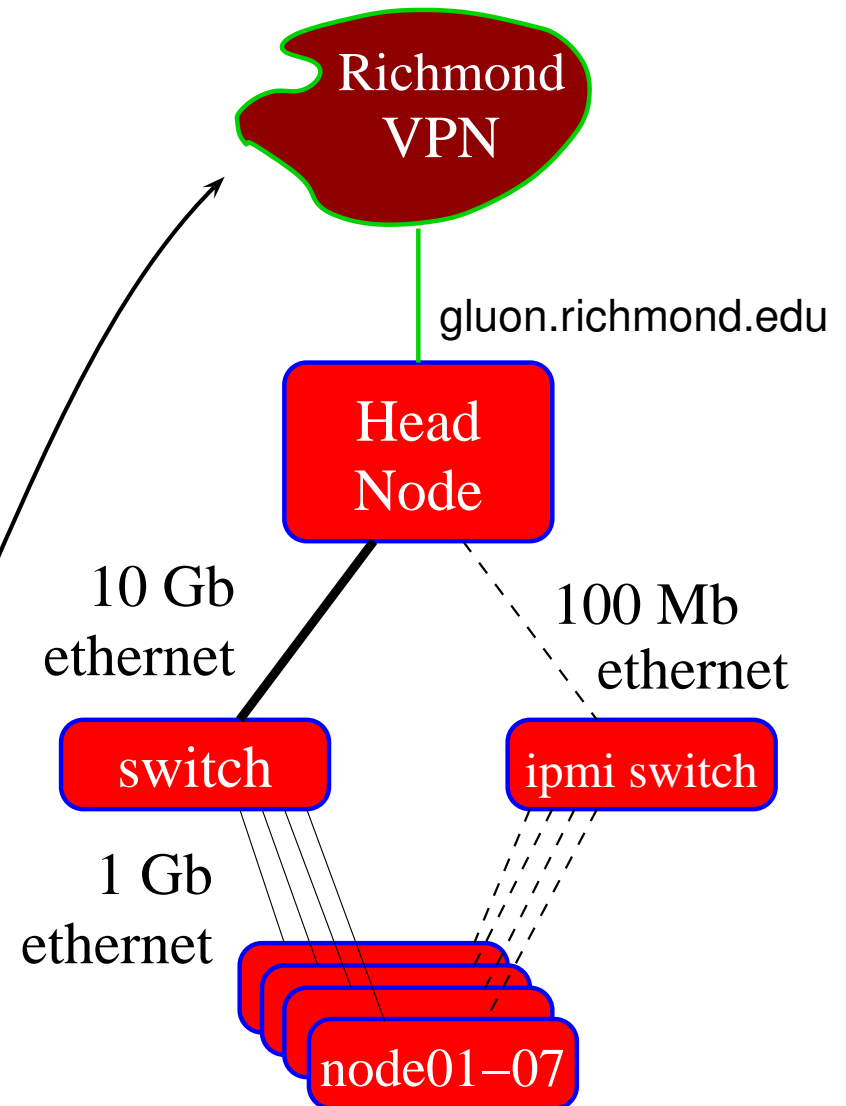

Why High-Performance Computing?

- The growth in computing power per dollar has spawned a revolution in computational science.
- The obvious ones: nuclear and particle physics, SETI, biological imaging, Amazon, Google, movies.
- Less obvious: pharmaceutical design, protein folding, financial forecasting, auto industry.
- Surprises: Home Depot, Walmart, Speedo, Oil companies, making concrete.
- Big Surprises: art,^a history, welding, small business.

^aIn 2008 the National Endowment for the Humanities collaborated with the U.S. Department of Energy to offer one million CPU hours on supercomputers by researchers in the humanities.

Accessing gluon from your machine

- Windows-based machines installation of WinSCP.
 1. Go to download page on <http://winscp.net/eng/index.php>.
 2. Click on the sponsored installation package entitled `winscp436setup-sponsored.exe` and save it to the desktop.
 3. Double-click it and choose all the defaults.
- Windows-based machines installation of PuTTY.
 1. Go to <http://www.chiark.greenend.org.uk/~sgtatham/putty/> and download `putty-0.62-installer.exe` to the Desktop.
 2. Double-click the installer and choose the defaults EXCEPT for "Create a desktop icon for PuTTY for all users".
- Mac-based machines already have have a terminal app for connecting to a remote machine - `ssh <netID>@gluon.richmond.edu`.
- Mac-based file-transfer GUIs:
 1. Cyberduck: <http://cyberduck.ch/>
 2. RBrowser: <http://www.rbrowser.com/>
 3. Fugu: <http://rsug.itd.umich.edu/software/fugu/>.

Project Introduction

1. What physics problem are you solving?
2. Why is it interesting? Why should I care?
3. Is it doable?
4. Must make use of Monte Carlo methods and the Richmond Computing Cluster.
5. The projects listed in the syllabus are suggestions only. Don't just copy one.

Uncertainty in Monte Carlo Calculations

Effect of Increasing N_{throws}

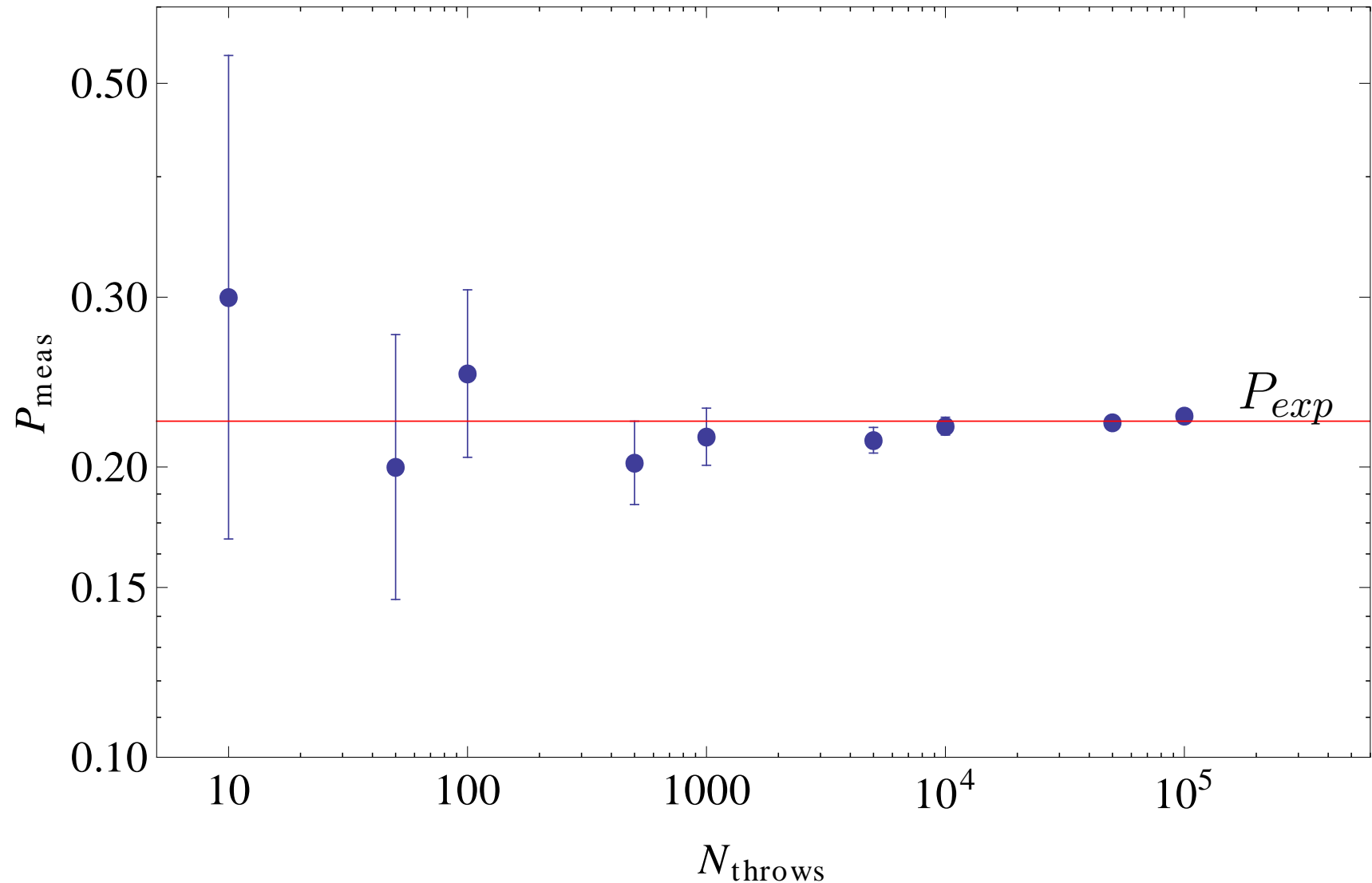

Richmond Computational Physics - The Cluster Development Model

- Do code development, testing, and debugging on the Physics lab machines.
- Prepare *Mathematica* notebooks for batch running on Physics lab machines.
- Upload *Mathematica* package files (“*.m”) to the cluster.
- Test run in batch on the head node for a small number of events.
- Test run in batch on the cluster for a small number of events.
- Full-up run on the cluster.
- Download results to Physics lab machines for final analysis.

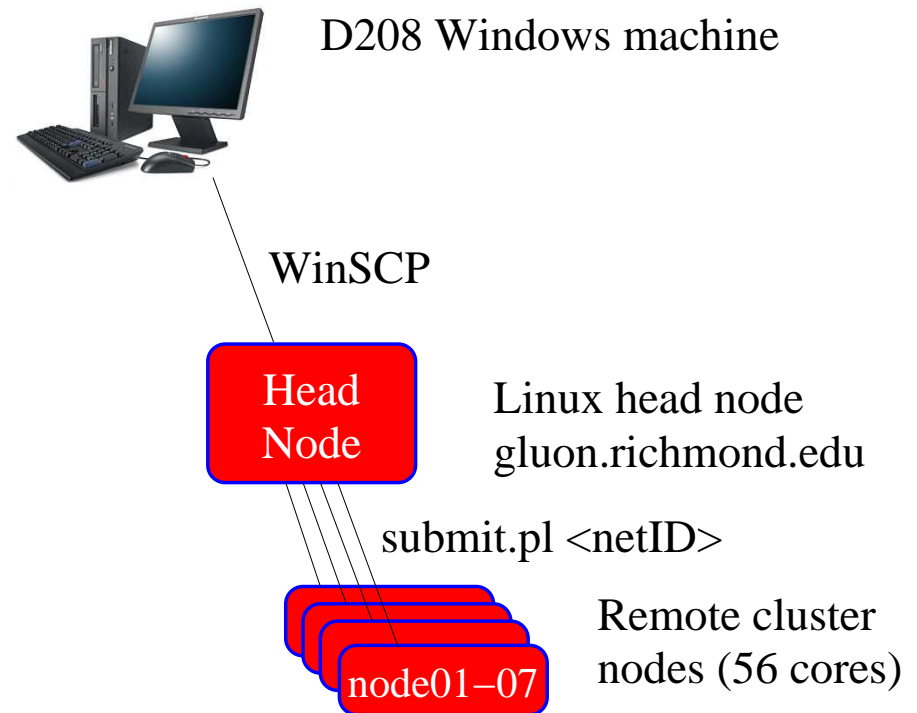

Rules for readable computer code.

- No 'hardwired' numbers! Give every quantity a name that will remind you of its meaning. Hardwired numbers will cost you dearly.
- Use abundant comments. Roughly one-third of the lines should be comments. Describe what you are doing and how. Add comments at the ends of multi-line loops and functions to identify the end.
- Use whitespace. Put blank lines between major segments of the code, *e.g.* the start of a loop.
- Use indentation. Arguments to loops, functions *etc.* and the following lines should be indented to help identify the range of these structures.
- For long, repetitive calculations use functions.
- An example is [here](#) along with a previous [example](#) of defining a function.

Monitor the Cluster - <http://gluon.richmond.edu/ganglia>



Phase-Space Portrait - 1

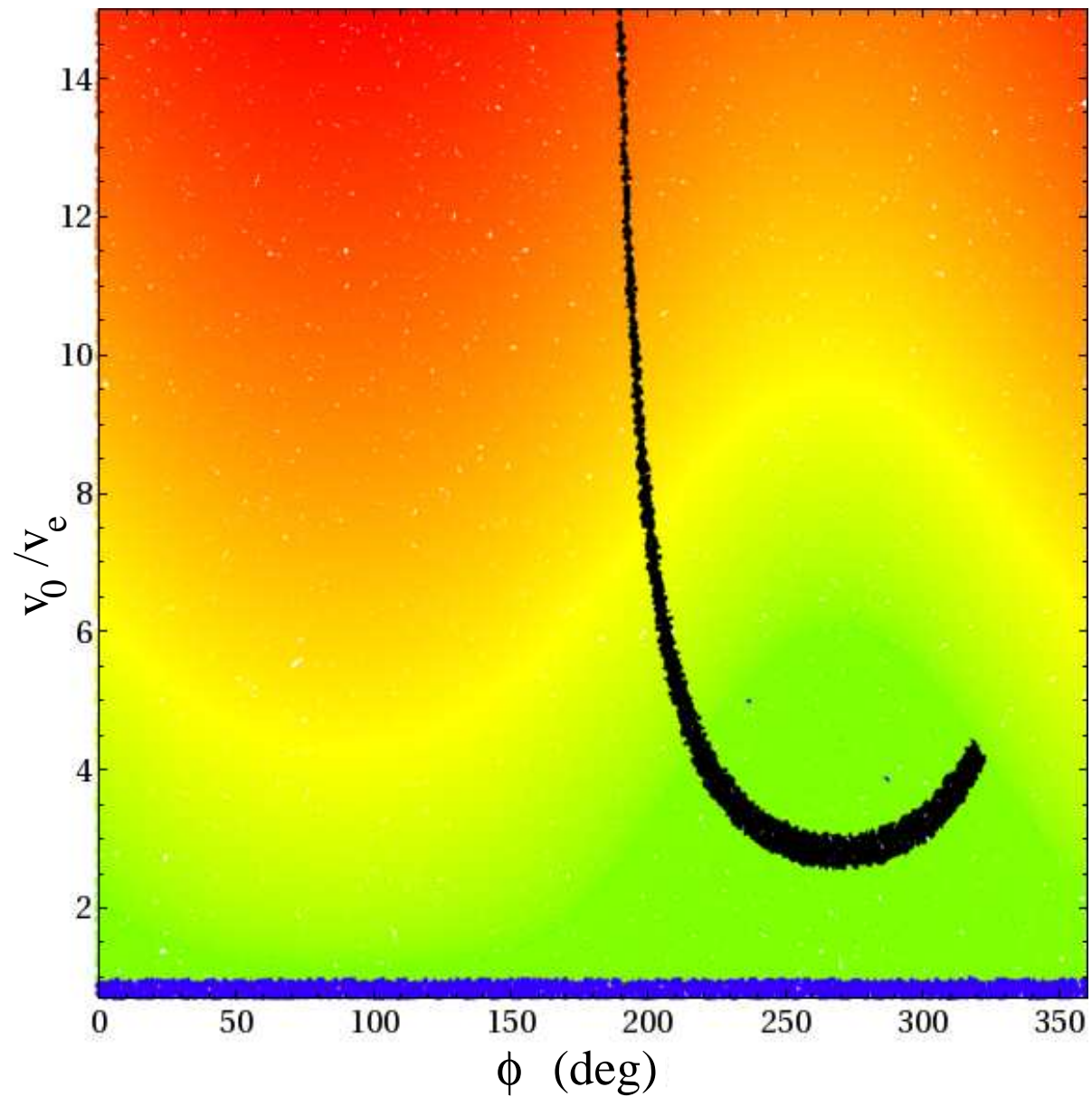

Phase-Space Portrait - 2

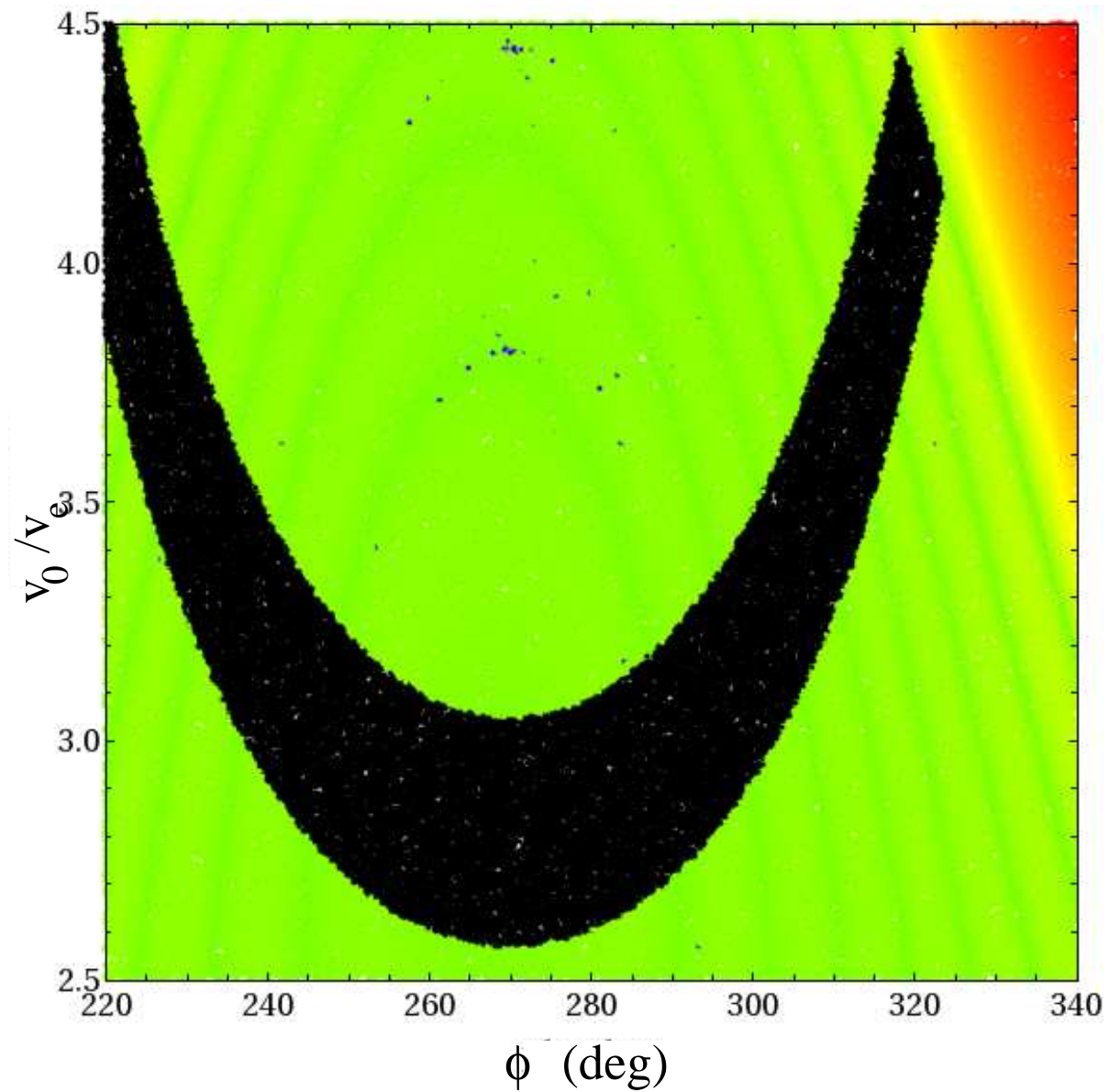

Phase-Space Portrait - 3

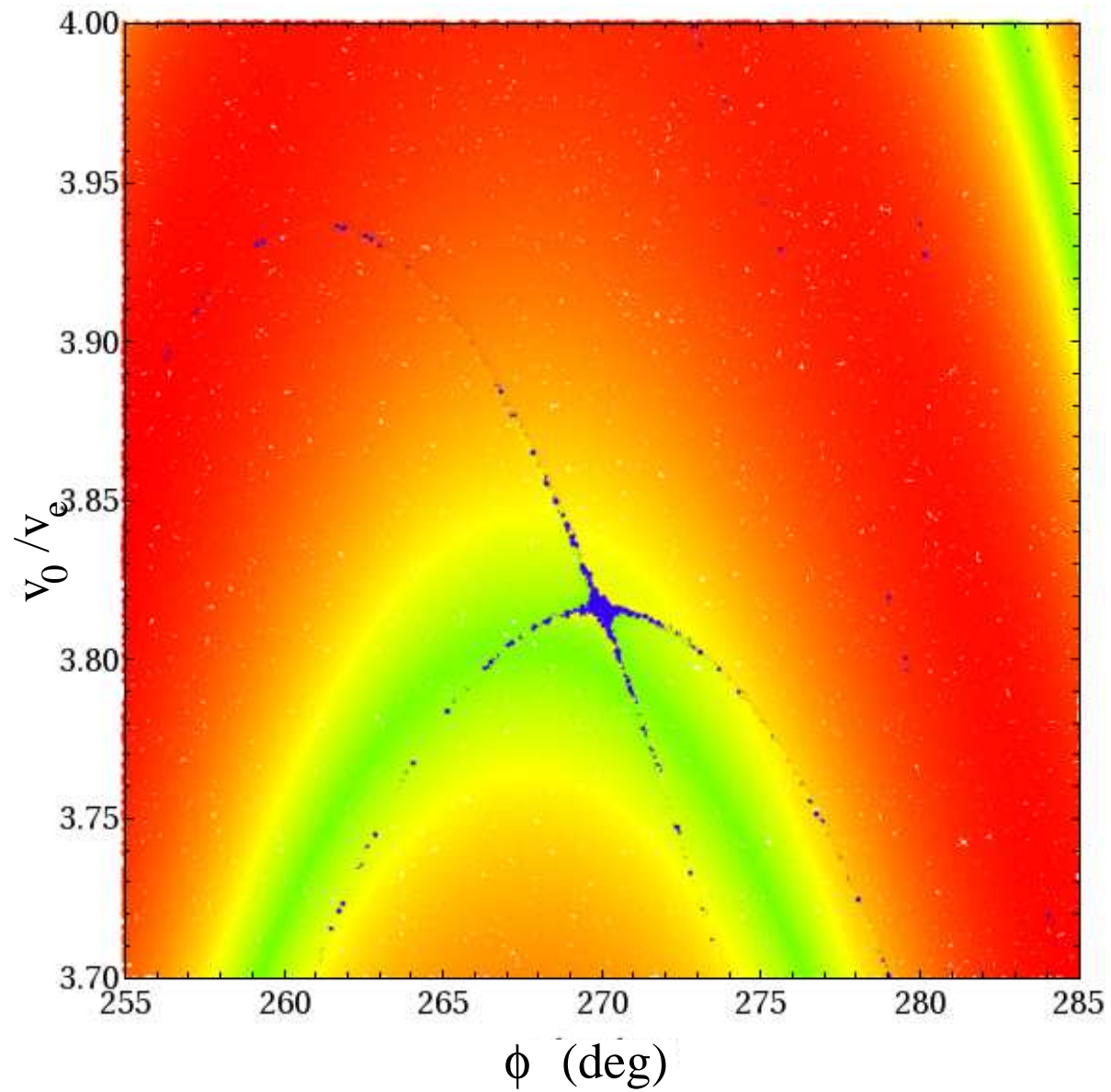

Phase-Space Portrait - 4

